



NP series
sealed rechargeable lead-acid battery

Application Manual



CONTENTS

	Page
INTRODUCTION	1
TECHNICAL FEATURES	1
APPLICATIONS	2
BATTERY CONSTRUCTION	2
GENERAL SPECIFICATIONS NP SERIES	3
GENERAL SPECIFICATIONS NPH SERIES	4
TERMINAL CONFIGURATIONS	4
BATTERY CAPACITY SELECTION CHARTS	5
DISCHARGE	6
Discharge Characteristics	6
Over-Discharge (Deep Discharge)	9
Maximum Discharge Current and Final Discharge Voltage	9
STORAGE, SELF-DISCHARGE AND SHELF LIFE	10
Self-Discharge	10
Shelf Life	10
Recharging Batteries in Storage	10
Impedance	10
Temperature Characteristics	11
CHARGING	11
Constant Voltage Charging	11
Constant Current Charging	14
Taper-Current Charging	15
Two Step Constant Voltage Charging	16
Charging Voltage	18
Initial Charge Current Limit	19
Charge Output Regulation and Accuracy	19
Top Charging	20
Recovery Charge after Deep Discharge	20
Temperature Compensation	21
Charging Efficiency	22
Solar Powered Charging	23
SERVICE LIFE	23
Cyclic Service Life	23
Float Service Life	24
TIPS & PRECAUTIONS	25
GLOSSARY	26

INTRODUCTION

Founded in 1918, Yuasa began development of the maintenance free sealed lead acid battery in 1958. Today's NP Series is the culmination of over seven decades of battery manufacturing experience.

High energy density, sealed leak proof construction, excellent performance in either float or cyclic applications and long service life combine to make the Yuasa NP Series the most reliable and versatile maintenance free rechargeable sealed lead acid batteries available.

TECHNICAL FEATURES

- Sealed Construction The unique construction and sealing techniques of the NP battery guarantee leakproof operation in any position with no adverse effect to capacity or service life.
- Electrolyte Suspension System All NP batteries utilize an electrolyte suspension system consisting of a high porosity, glass fiber material which in conjunction with plates, totally absorb and contain the electrolyte. No silica gels or any other contaminants are used.
- Gas Generation NP batteries incorporate a built-in design that controls gas generation and induces recombination of more than 99% of gases generated during float usage.
- Maintenance Free Operation There is no need to check specific gravity of the electrolyte or add water to NP batteries during float service life. In fact, there is no provision for this type of maintenance.
- Low Pressure Valve Regulated System.. All NP batteries are equipped with safety release valves, designed to operate between 2 and 5 psi and automatically reseal. Hence, there is never an excessive accumulation of gas within the battery.
- Heavy Duty Grids Heavy duty lead calcium tin alloy grids provide an extra margin of performance and service life in either float or cyclic applications, even after repeated over discharges.
- Cyclic Service Life More that 1000 discharge/recharge cycles can be realized from Yuasa NP batteries, dependent on the average depth of discharge.
- Float Service Life NP Series batteries have an expected life span of 3 to 5 years in float service applications.
- Self Discharge - Shelf Life The self discharge rate of the NP series at room temperature is approximately 3% of rated capacity per month.
- Operating Temperature Yuasa NP Batteries may be operated over a broad range of ambient temperatures.
- Deep Discharge Recovery NP batteries recover their capacities even after repeated deep discharges.

APPLICATIONS

A partial list of common applications include:

FLOAT SERVICE

- Burglar and Fire Alarm
- Office Machines
- Cash Registers
- Solar Power Devices
- Telecommunications
- U.P.S. Equipment
- Emergency Lighting
- Computers

CYCLIC SERVICE

- Audio & Video Equipment
- Portable Lights
- Electric Wheelchairs
- Test Equipment
- Geophysical Equipment

FLOAT/CYCLIC SERVICE

- Medical Equipment
- Communications
- Cellular Telephones

YUASA NP BATTERY CONSTRUCTION

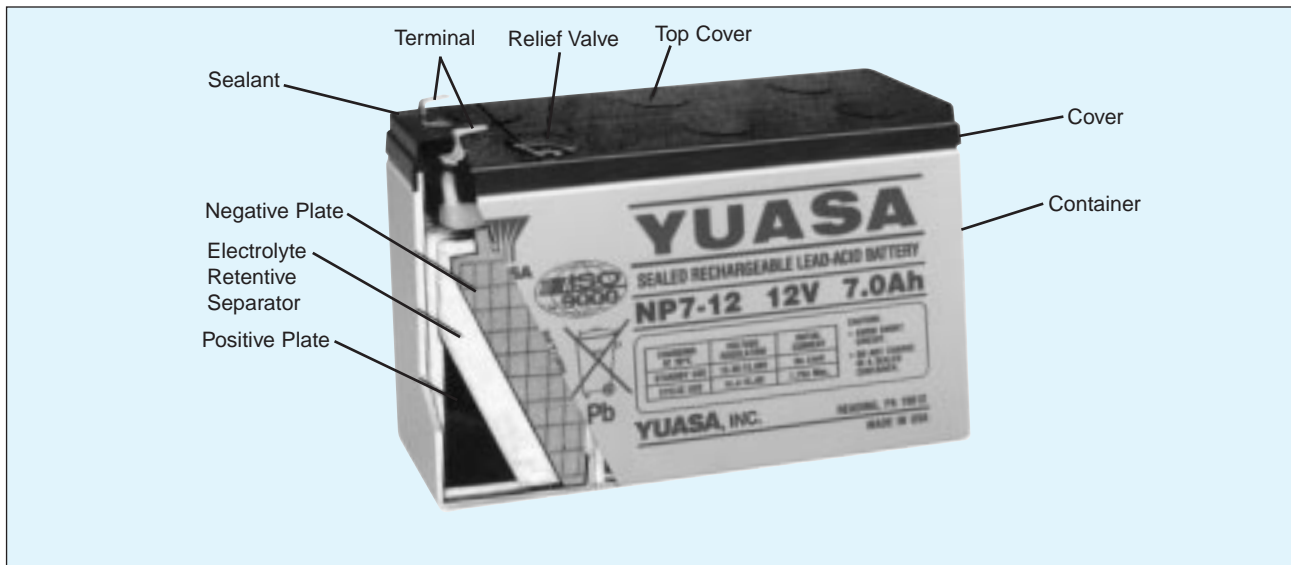

**SEALED LEAD BATTERY
MUST BE RECYCLED OR
DISPOSED OF PROPERLY**

GENERAL SPECIFICATIONS NP SERIES

NPH SERIES

Type	FR Type*	Volts	Nominal Capacity (10 hr rate - Ah)	Length		Width		Overall Height Incl. Terminals		Weight		Layout	Terminals
				mm.	(in.)	mm	(in.)	mm.	(in.)	kgs.	(lbs.)		
NPH2-12	NPH2-12FR	12	2.0	68.0	2.68	51.0	2.01	88.0	3.46	0.84	1.85	2	A
NPH3.2-12	NPH3.2-12FR		3.2	134.0	5.28	67.0	2.64	64.0	2.52	1.40	3.09	3	A

NP SERIES

			20 hr Rate (Ah)										
NP4.2-4H	-	4	4.2	48.0	1.89	35.5	1.40	119.0	4.68	0.56	1.23	6	-
NP1.2-6	NP1.2-6FR	6	1.2	97.0	3.82	25.0	0.98	54.5	2.15	0.30	0.66	1	A
NP3-6	-		3.0	134.0	5.28	34.0	1.33	64.0	2.52	0.65	1.43	1	A
NP4-6	-		4.0	70.0	2.76	47.0	1.85	105.5	4.15	0.85	1.87	5	A
NP7-6	NP7-6FR		7.0	151.0	5.95	64.0	1.33	97.5	3.84	1.35	2.98	1	A/D
NP10-6	NP10-6FR		10.0	151.0	5.95	50.0	1.97	97.5	3.84	2.00	4.41	1	A/D
NP0.8-12	NP0.8-12FR**	12	0.8	96.0	3.78	25.0	0.98	61.5	2.42	0.35	0.77	7	I
NP1.2-12	NP1.2-12FR		1.2	97.0	3.82	48.0	1.89	54.5	2.15	0.57	1.25	3	A
NP2-12	-		2.0	150.0	5.91	20.0	0.79	89.0	3.50	0.70	1.54	8	B
NP2.3-12	NP2.3-12FR		2.3	178.0	7.01	34.0	1.34	64.0	2.52	0.94	2.07	1	A
NP2.6-12	NP2.6-12FR		2.6	134.0	5.28	67.0	2.64	64.0	2.52	1.12	2.47	3	A
NP4-12	NP4-12FR		4.0	90.0	3.54	70.0	2.76	106.0	4.17	1.70	3.74	1	A/D
NP7-12	NP7-12FR		7.0	151.0	5.94	65.0	2.56	97.5	3.84	2.65	6.17	4	A/D
NP12-12	NP12-12FR		12.0	151.0	5.94	98.0	3.86	97.5	3.84	4.00	8.82	4	D
NP18-12B	NP18-12BFR		17.2	181.0	7.13	76.2	2.99	167.0	6.57	6.20	13.64	2	E
NP24-12	NP24-12FR		24.0	166.0	6.54	175.0	6.89	125.0	4.92	8.65	19.05	2	C
NP24-12B	NP24-12BFR		24.0	166.0	6.54	175.0	6.89	125.0	4.92	8.65	19.05	2	E
-	NP26-12B		26.0	166.0	6.54	125.0	4.92	175.0	6.89	9.30	20.50	2	J
-	NP26-12R		26.0	166.0	6.54	125.0	4.92	175.0	6.89	9.30	20.50	2	K
-	NP38-12B		38.0	197.0	7.74	165.0	6.50	175.0	6.89	13.80	30.40	2	F
-	NP38-12R		38.0	197.0	7.74	165.0	6.50	175.0	6.89	13.80	30.40	2	K
NP65-12	NP65-12FR	65.0	350.0	13.78	166.0	6.54	174.0	6.85	22.80	50.20	2	G	

W/Cell to 1.67
End Voltage
(15 Min Rate)

NPX SERIES

NPX-50	NPX-50FR	6	50W/Cell	151.0	5.95	50.0	1.97	97.5	3.84	2.00	4.41	1	A/D
NPX-25	NPX-25FR	12	23W/Cell	90.0	3.54	70.0	2.75	106.0	4.17	2.00	4.41	1	D
NPX-35	NPX-35FR		35W/Cell	151.0	5.94	65.0	2.56	97.5	3.84	2.67	6.24	4	A/D
NPX-80B	NPX-80B		80W/Cell	181.0	7.13	76.2	2.99	167.0	6.57	6.60	14.50	2	E
-	NPX-100B		95W/Cell	166.0	6.54	125.0	4.92	175.0	6.89	9.30	20.80	2	J
-	NPX-100R		95W/Cell	166.0	6.54	125.0	4.92	175.0	6.89	9.30	20.80	2	K
-	NPX-150B		150W/Cell	197.0	7.76	165.0	6.50	175.0	6.89	15.50	34.10	2	J
-	NPX-150R		150W/Cell	197.0	7.76	165.0	6.50	175.0	6.89	15.50	34.10	2	K

FOOTNOTES:

- * FR: Containers and covers made from Flame Retardant materials (UL1778 and UL94/L.O.I.28%).
- ** FR: Containers and covers made from Flame Retardant materials UL1778 and UL94-V2, L.O.I.28%).
- † Recognized by UI File No. MH 12970
- Recognized by UI File No. MH16464 - Made in the USA (Hays, KS)

All data is subject to change without notice

• LAYOUT

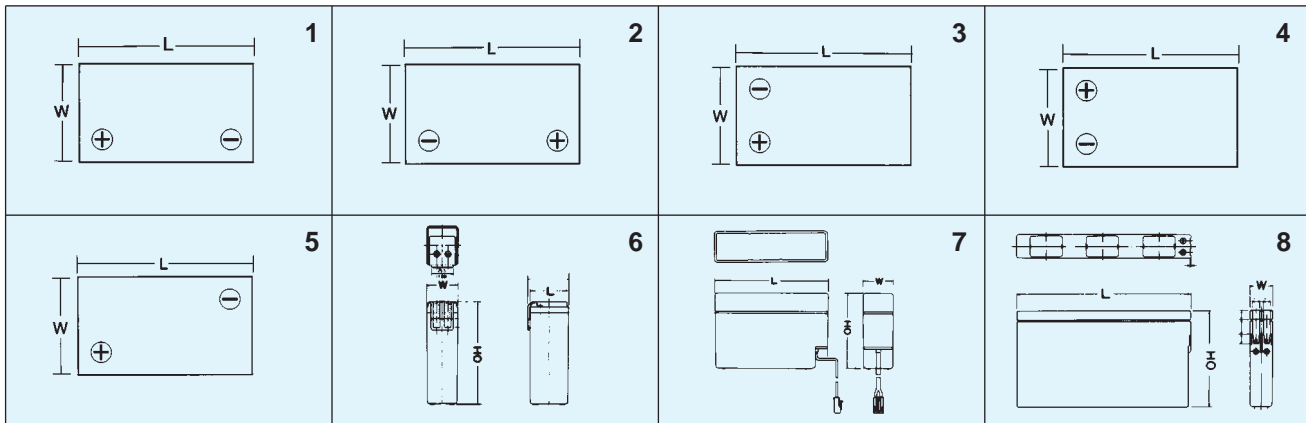

• TERMINAL

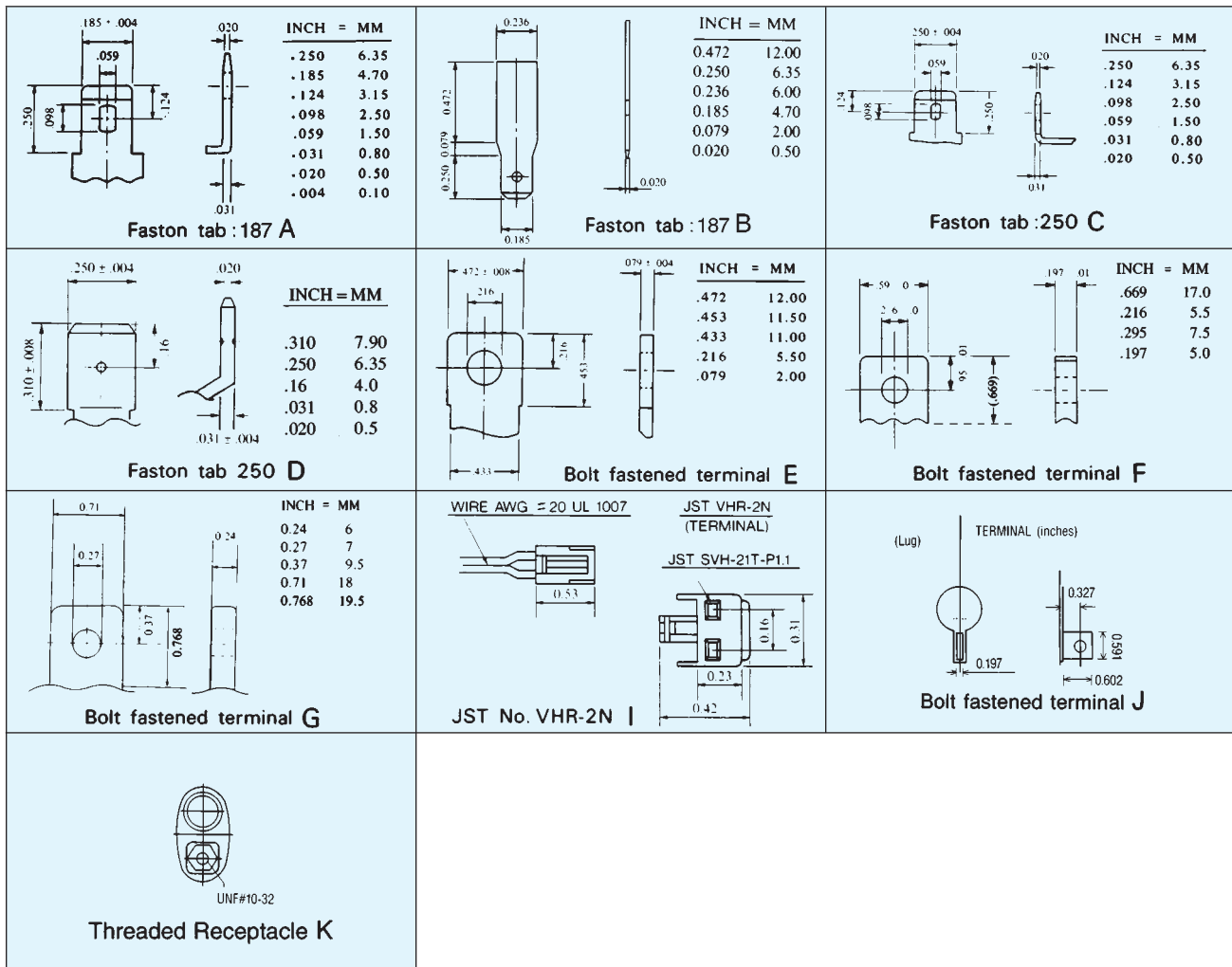

BATTERY CAPACITY SELECTION

Figures 1 and 2 may be used to determine battery size (expressed in Ampere Hours of capacity), for a specific application. To determine the capacity of the battery, establish the discharge current for the length of discharge

time required. The point where the current and time lines intersect is the minimum capacity battery needed for the application. It is recommended you refer to Figures 3, 26, 30, & 31 before making your final decision.

Figure 1. 20-HOUR RATE CAPACITY SELECTION CHART

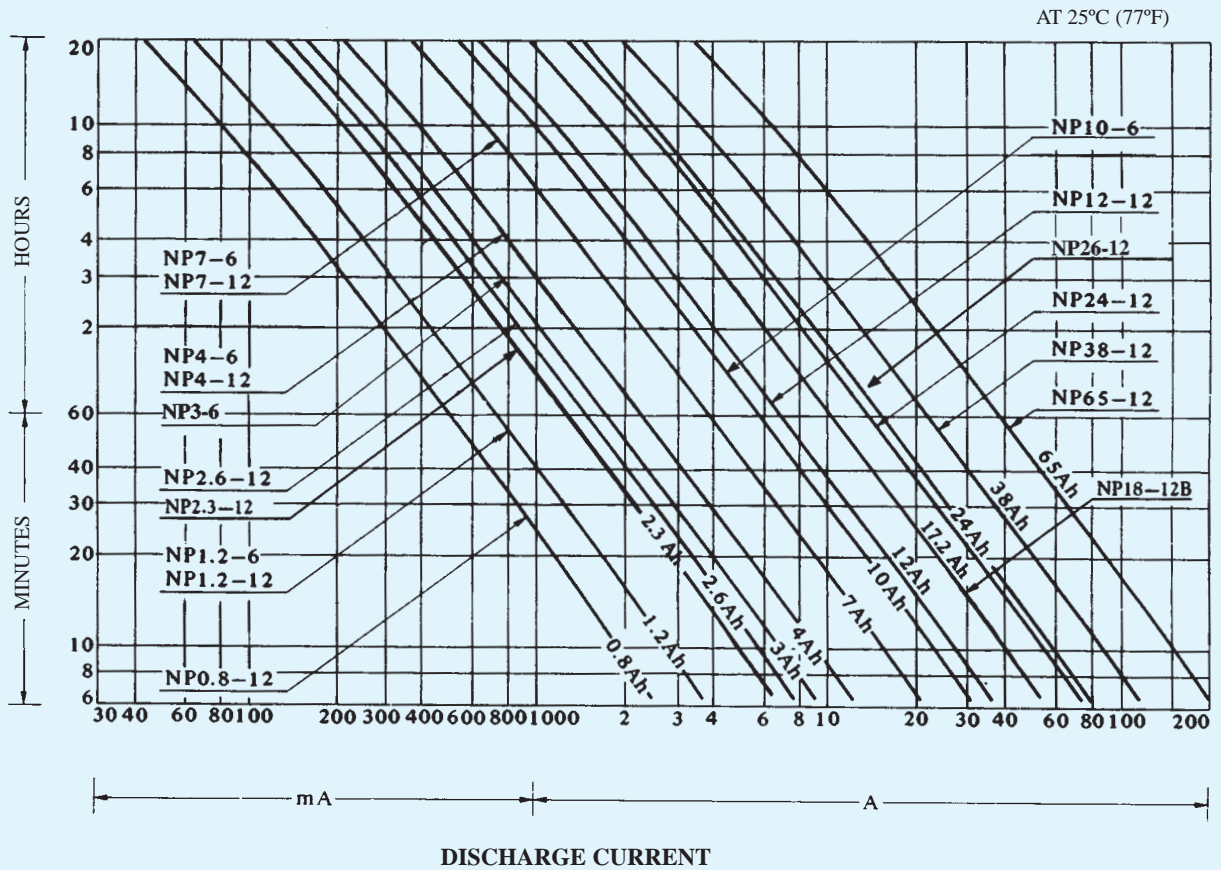

NPH SERIES CHARACTERISTIC CURVES

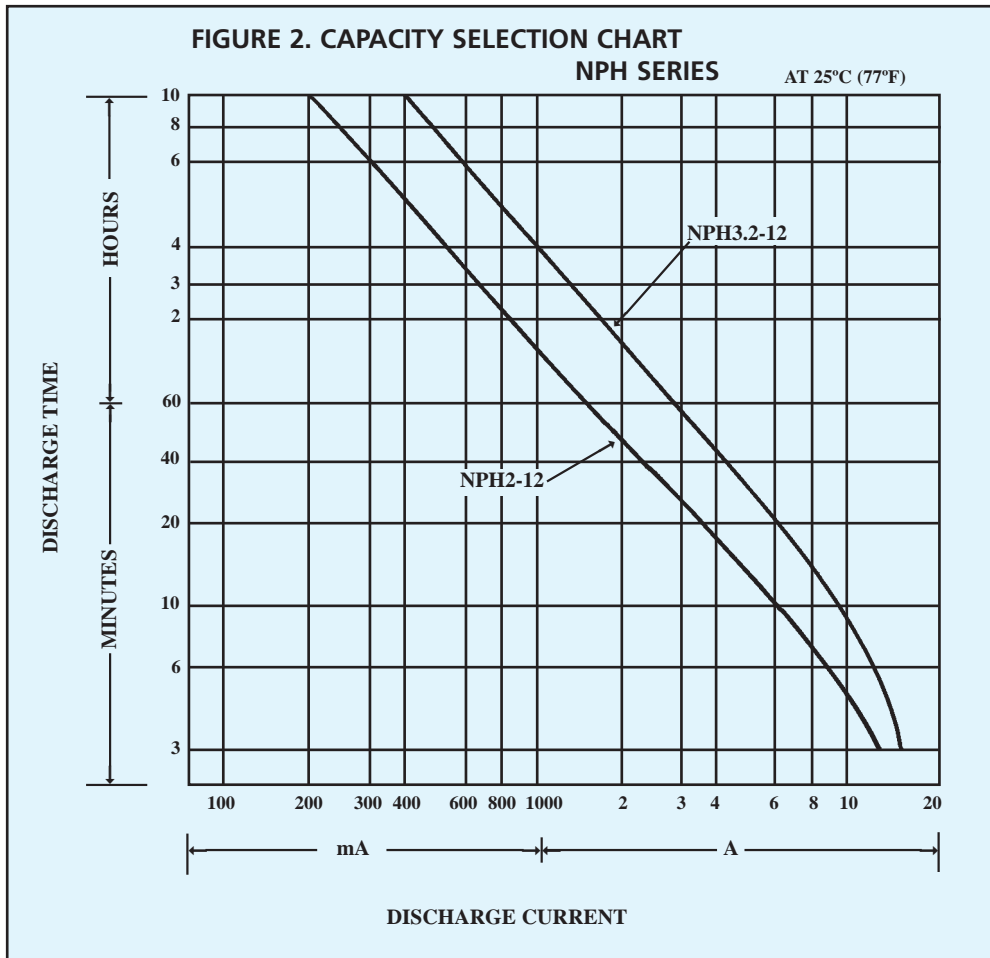

DISCHARGE

■ Discharge Characteristics

The curves shown in Figures 1, 2, 3, & 4 and the discharge rates shown in Tables 1, 2, & 3 illustrate the typical discharge characteristics of NP and NPH batteries at an ambient temperature of 25°C (77°F). The symbol "C" expresses the nominal capacity of the NP battery, measured at a 20 hour discharge rate and the NPH at a 10 hour discharge rate. Please refer to General Specifications to determine the nominal capacity rating of the specific model.

The industry standard for designating the nominal capacity of a sealed lead acid battery involves a discharge test for a given number of hours to a final pre-set end voltage. The average current value multiplied by the hours of discharge time determines the capacity rating of that particular battery. Since manufacturers vary in their rating standards, it is always a good practice to question the rating standard.

Tables 1 and 2 show how the rated nominal capacity decreases when the discharge load is higher than the 20 hour rate. These tables should be consulted when selecting a battery for a high discharge application.

The discharge rates depicted in Tables 2.5 reference watts per cell of the NPX series of batteries. These batteries are designed for Uninterruptable Power Supply (UPS) applications where high rate discharge performance (under 30 minutes) is typical. To determine the battery kilowatt rating required for a UPS system, refer to the following formula:

KVA rating of UPS x Power Factor (P_f) ÷ inverter efficiency = Total Battery Kilowatts (KWB).

Figure 3.

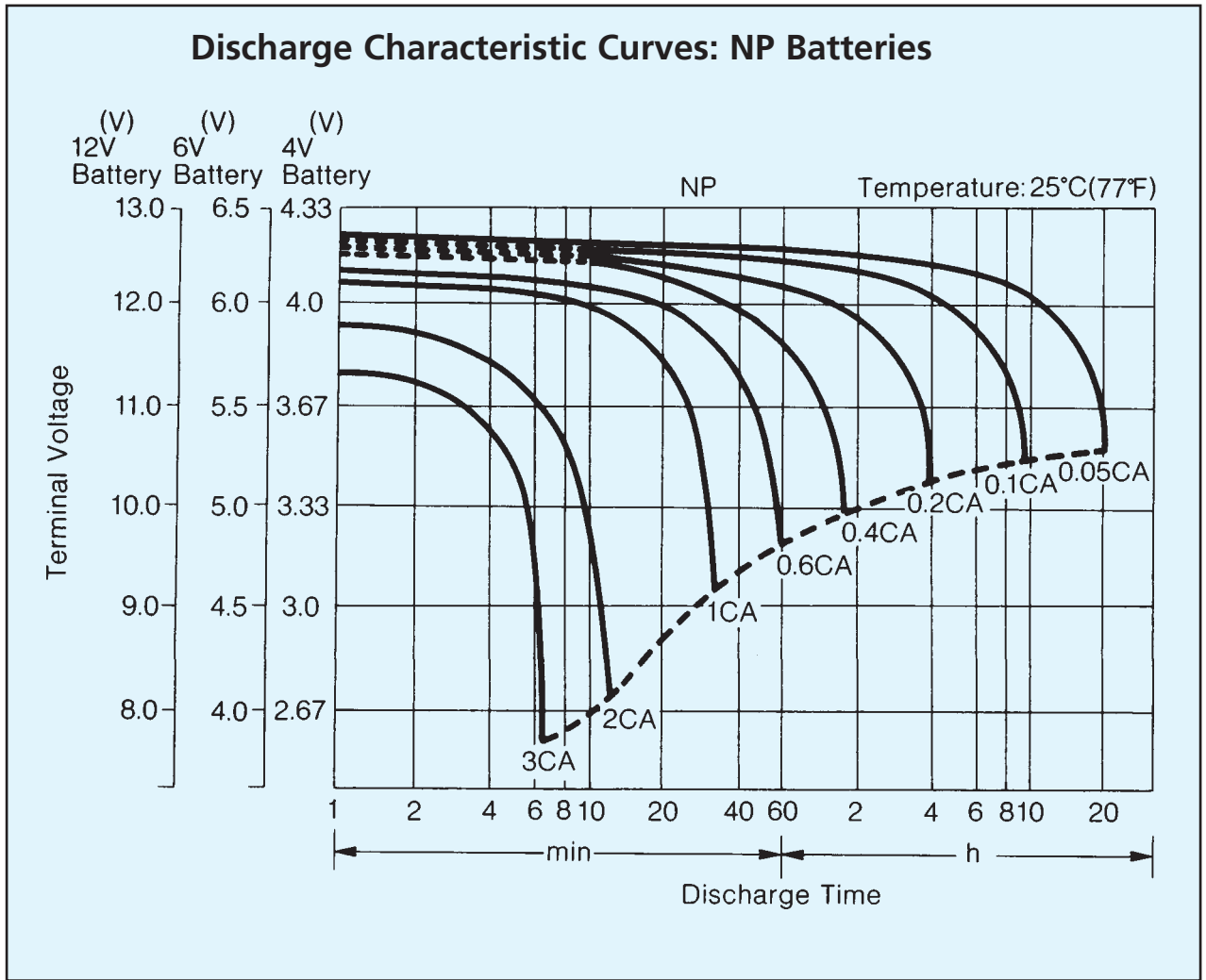

Figure 4.

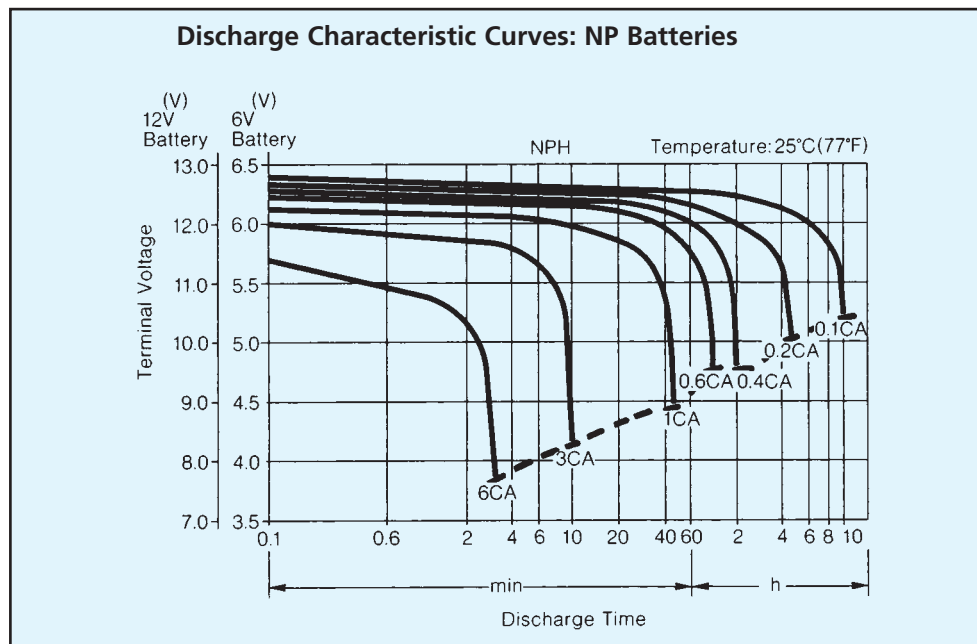

Table 1. DISCHARGE CURRENT AT STIPULATED DISCHARGE RATES

20 H.R. Capacity	Discharge Current							
	0.05C	0.1C	0.2C	0.4C	0.6C	1C	2C	3C
0.8 A	0.04 A	0.08 A	0.16 A	0.32 A	0.48 A	0.8 A	1.6 A	2.4 A
1.2	0.06	0.12	0.24	0.48	0.72	1.2	2.4	3.6
2.0	0.10	0.20	0.40	0.80	1.20	2.0	4.0	6.0
2.3	0.12	0.23	0.46	0.92	1.38	2.3	4.6	6.9
2.6	0.13	0.26	0.52	1.04	1.56	2.6	5.2	7.8
3.0	0.15	0.30	0.60	1.20	1.80	3.0	6.0	9.0
4.0	0.20	0.40	0.80	1.60	2.40	4.0	8.0	12.0
7.0	0.35	0.70	1.40	2.80	4.20	7.0	14.0	21.0
10.0	0.50	1.00	2.00	4.00	6.00	10.0	20.0	30.0
12.0	0.60	1.20	2.40	4.80	7.20	12.0	24.0	36.0
17.2	0.86	1.72	3.44	6.88	10.32	17.2	34.4	51.6
24.0	1.20	2.40	4.80	9.60	14.40	24.0	48.0	72.0
26.0	1.30	2.60	5.20	10.40	15.60	26.0	52.0	78.0
38.0	1.90	3.80	7.60	15.20	22.80	38.0	76.0	114.0
65.0	3.25	6.50	13.00	26.00	39.00	65.0	130.0	195.0

Table 2. DISCHARGE CURRENT AT STIPULATED DISCHARGE RATES (NPH)

10 Hr. Capacity	Discharge Current							
	0.01C	0.2C	0.4C	0.6C	0.8C	1C	2C	3C
2.0	0.20	0.40	0.80	1.20	1.40	2.00	4.00	6.00
3.2	0.32	0.64	1.28	1.90	2.54	3.20	6.40	9.60

Table 2.5 NPX WATTS PER CELL TO 1.67 END VOLTAGE

	5 MIN	10 MIN	15 MIN	20 MIN
NPX-25	47	31	23	18
NPX-50	94	60	50	38
NPX-35	66	45	35	29
NPX-80	155	104	80	65
NPX-100	185	125	95	75
NPX-150	285	200	150	120

Table 3. DISCHARGE CAPACITY AT VARIOUS DISCHARGE RATES

20 Hr. Capacity	Discharge Capacity				
	20 Hr.	10 Hr.	5 Hr.	3 Hr.	1 Hr.
	0.05CA to 1.75 V/C	0.093CA to 1.75 V/C	0.17CA to 1.70 V/C	0.25CA to 1.67 V/C	0.60CA to 1.55 V/C
0.8 Ah	0.8 Ah	0.74 Ah	0.68 Ah	0.62 Ah	0.48 Ah
1.2	1.2	1.1	1.0	0.9	0.7
2.0	2.0	1.9	1.7	1.6	1.2
2.3	2.3	2.2	2.0	1.8	1.4
2.6	2.6	2.4	2.2	2.0	1.6
3.0	3.0	2.8	2.6	2.3	1.8
4.0	4.0	3.7	3.4	3.1	2.4
7.0	7.0	6.5	6.0	5.4	4.2
10.0	10.0	9.3	8.5	7.7	6.0
12.0	12.0	11.2	10.2	9.2	7.2
17.2	17.2	16.0	14.6	13.2	10.3
24.0	24.0	22.3	20.4	18.5	14.4
26.0	26.0	24.2	22.1	20.0	15.6
38.0	38.0	35.0	32.3	29.3	22.8
65.0	65.0	60.5	55.2	50.1	39.0

■ Over-Discharge (Deep Discharge)

The dotted line in Figures 3 & 4 indicates the lowest recommended voltage under load, or cut-off voltage, at various discharge rates. In general, lead acid batteries are damaged in terms of capacity and service life if discharged below the recommended cut-off voltages. It is generally recognized that all lead calcium alloy grid batteries are subject to over-discharge damage. For example, if a lead acid battery were discharged to zero and left in either open or closed circuit for a long period of time, severe sulfation and shorting would occur, thus

raising the internal resistance abnormally high. In such an extreme case, the battery may not accept a charge.

Yuasa NP Series batteries however, have been designed to withstand such occasional over discharge. While it is not recommended, NP batteries can recover their full capacity under normal charging conditions, even when they have been subjected to extreme over discharge.

Final discharge voltage is as shown in Table 4.

Table 4. FINAL DISCHARGE VOLTAGE

Discharge Current	Final Discharge Voltage (V/Cell)
0.1 C or below, or Intermittent discharge	1.75
0.1 7C or current close to it	1.70
0.26C or current close to it	1.67
0.6C or current close to it	1.60
From 0.6C to 3C	1.50
Current in excess of 3C	1.30

When considering discharge currents exceeding 3C, consult with a Yuasa Application Engineer.

STORAGE, SELF-DISCHARGE and SHELF LIFE

■ Self-Discharge

The self-discharge rate of NP batteries is approximately 3% per month when the storage temperature is maintained at 20°C (68°F). The self-discharge rate will vary

with storage temperature and the remaining capacity.

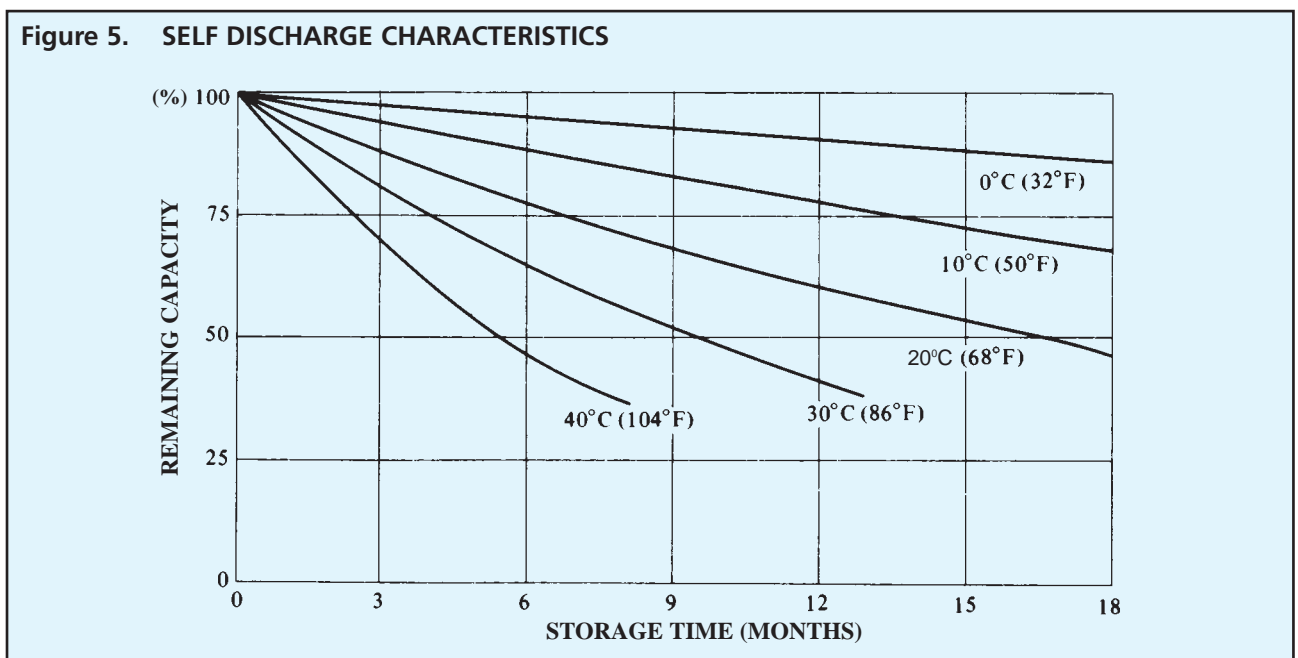

■ Shelf Life

In general, when lead acid batteries of any type are stored in a discharged condition for extended periods of time, lead sulfate is formed on the negative plates of the batteries. This phenomenon is referred to as "sulfation". Since the lead sulfate acts as an insulator, it has a direct detrimental effect on charge acceptance. The more advanced the sulfation, the lower the charge acceptance.

Table 5 below shows the normal storage time or shelf life at various ambient temperatures.

Table 5. Shelf Life at Various Temperatures

Temperature	Shelf Life
0°C (32°F) to 20°C (68°F)	12 months
21°C (70°F) to 30°C (86°F)	9 months
31°C (88°F) to 40°C (104°F)	5 months
41°C (106°F) to 50°C (122°F)	2.5 months

"Brief usage", ie., a few days, at temperatures higher than the ranges recommended, will have no adverse effect on storage time or service life. However, if such use continues for more than one month, the storage time must be determined according to the new ambient temperature.

■ Recharging Stored Batteries

In general, to optimize performance and service life, it is recommended that NP batteries which are to be stored for extended periods of time be given a supplementary charge, commonly referred to as a "top charge", periodically. Please refer to the recommendations listed on page 20 under TOP CHARGING.

IMPEDANCE

The internal resistance (impedance) of a battery is lowest when the battery is in a fully charged state. The internal resistance increases gradually during discharge, Figure 6

shows the internal resistance of an NP battery measured through a 1,000 Hz AC bridge.

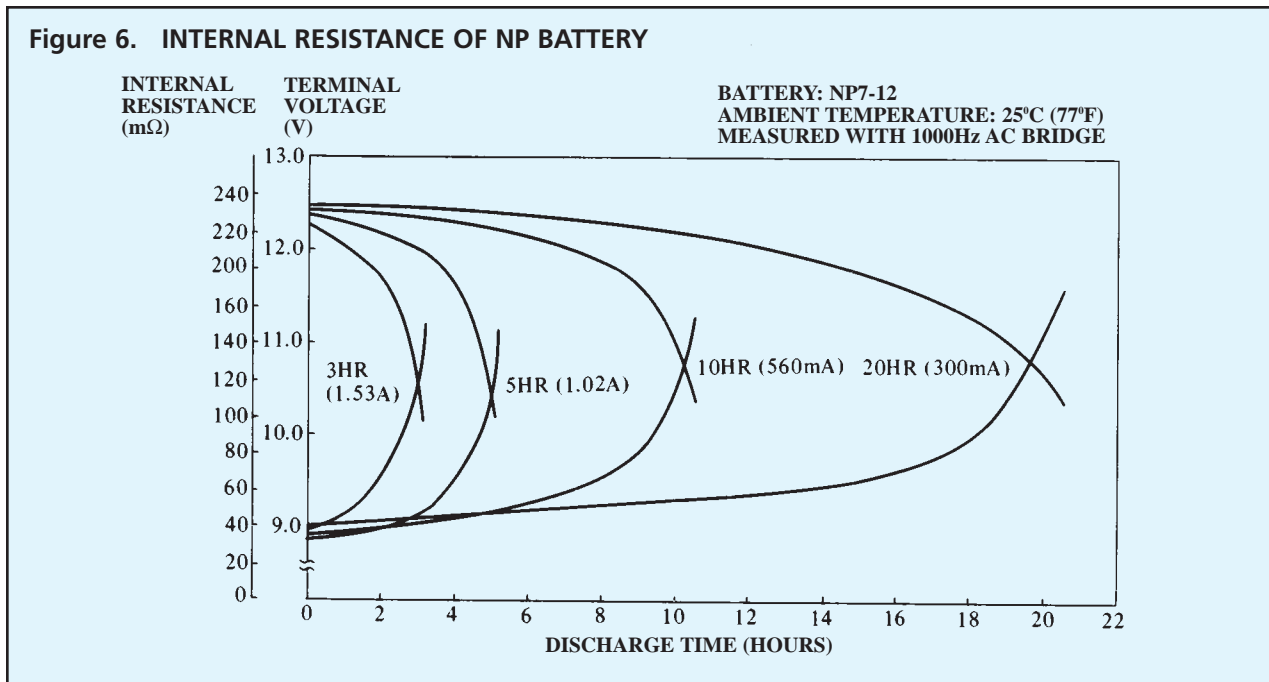

■ **Temperature characteristics**

At higher temperatures, the electrical capacity that can be taken out of a battery increases. At lower temperatures, the electrical capacity that can be taken out of a

battery decreases. Figure 7 shows the temperature effects in relation to battery capacity.

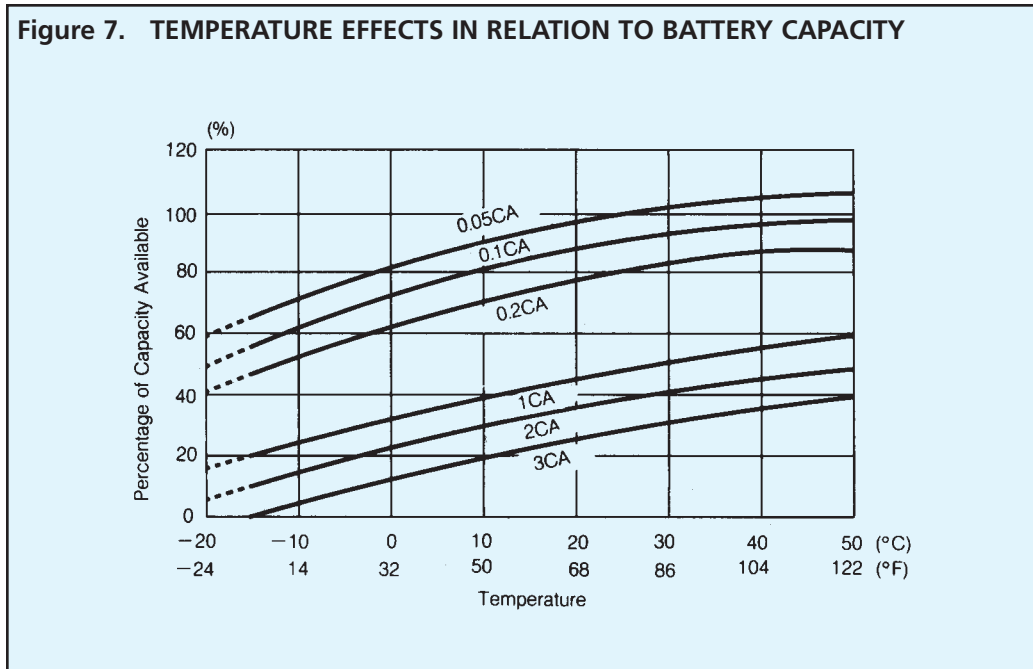

CHARGING

Proper charging is one of the most important factors to consider when using maintenance free sealed lead-acid batteries. Battery performance and service life will be directly effected by the efficiency of the charger selected. The four charging methods are:

- Constant Voltage Charging
- Constant Current Charging
- Taper-Current Charging
- Two Step Constant-Voltage Charging

■ **Constant-Voltage Charging**

Charging at constant voltage is the most suitable, and commonly used method for charging sealed lead-acid batteries. Figures 8 through 13 show the charging characteristics of NP batteries when charged by constant voltage chargers at 2.30 volts/cell, 2.40 volts/cell and 2.50 volts/cell, when the initial charging current is controlled at 0.1CA, and 0.25CA.

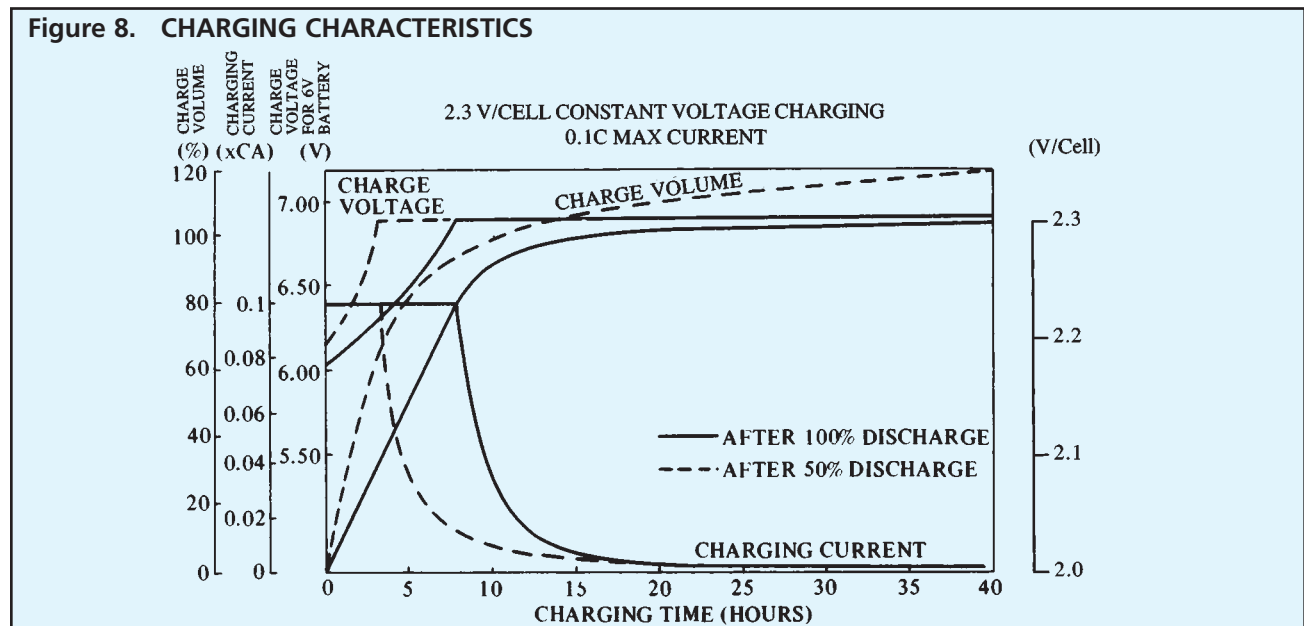

Figure 9. CHARGING CHARACTERISTICS

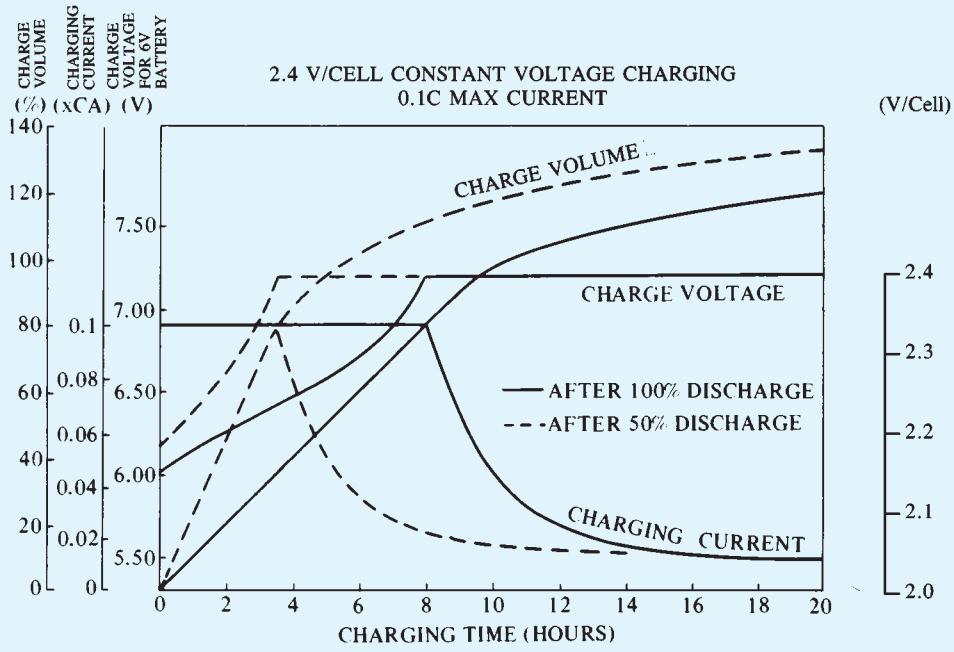

Figure 10. CHARGING CHARACTERISTICS

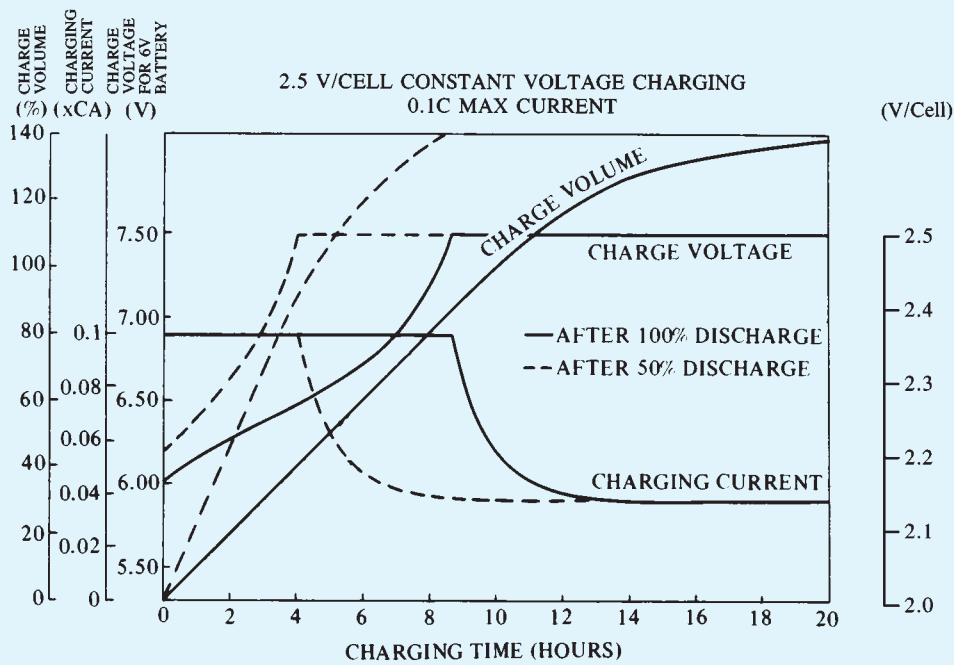

Figure 11. CHARGING CHARACTERISTICS

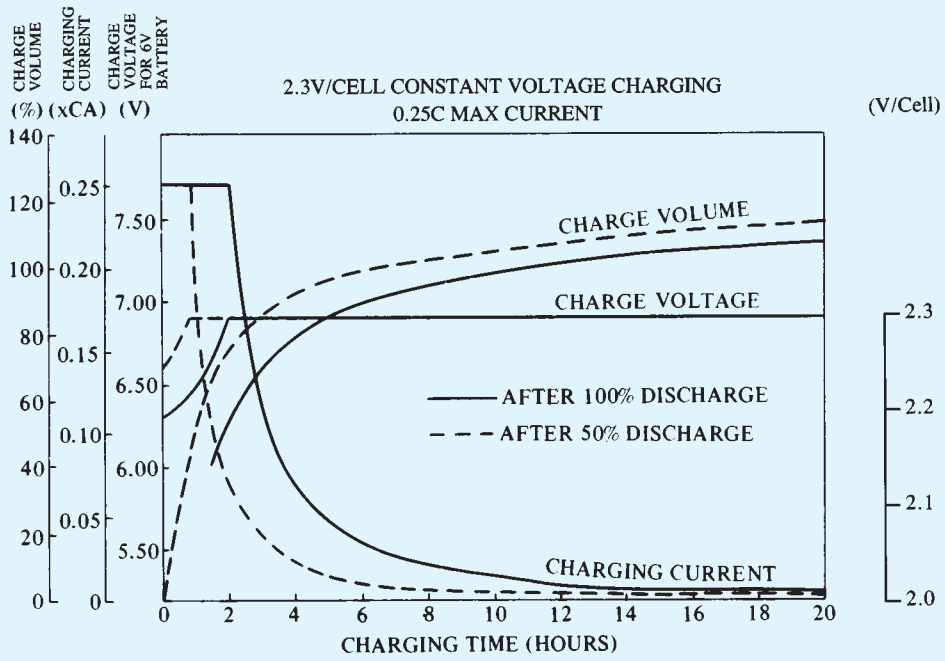

Figure 12. CHARGING CHARACTERISTICS

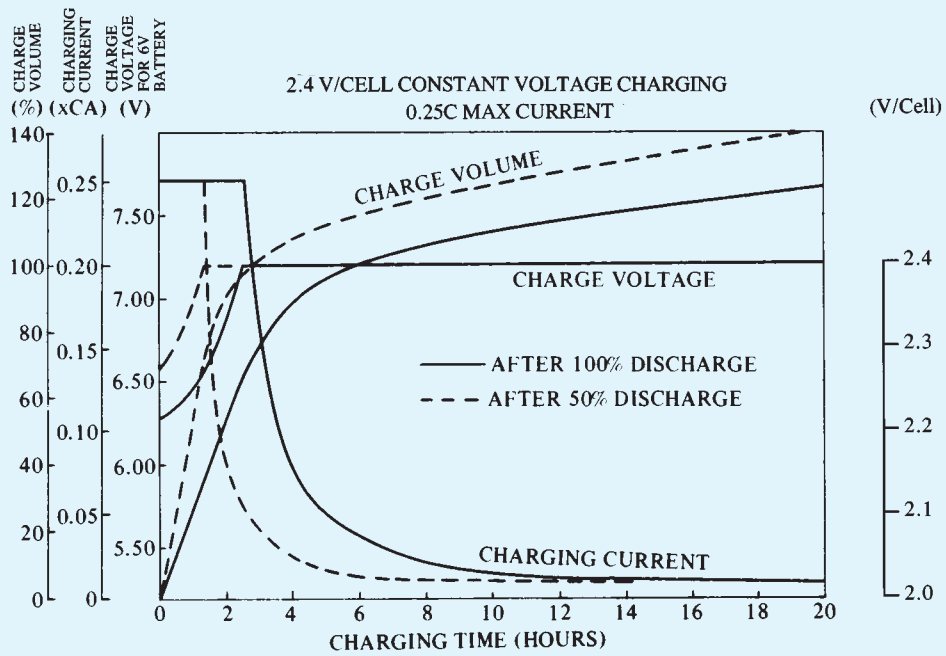

Figure 13. CHARGING CHARACTERISTICS

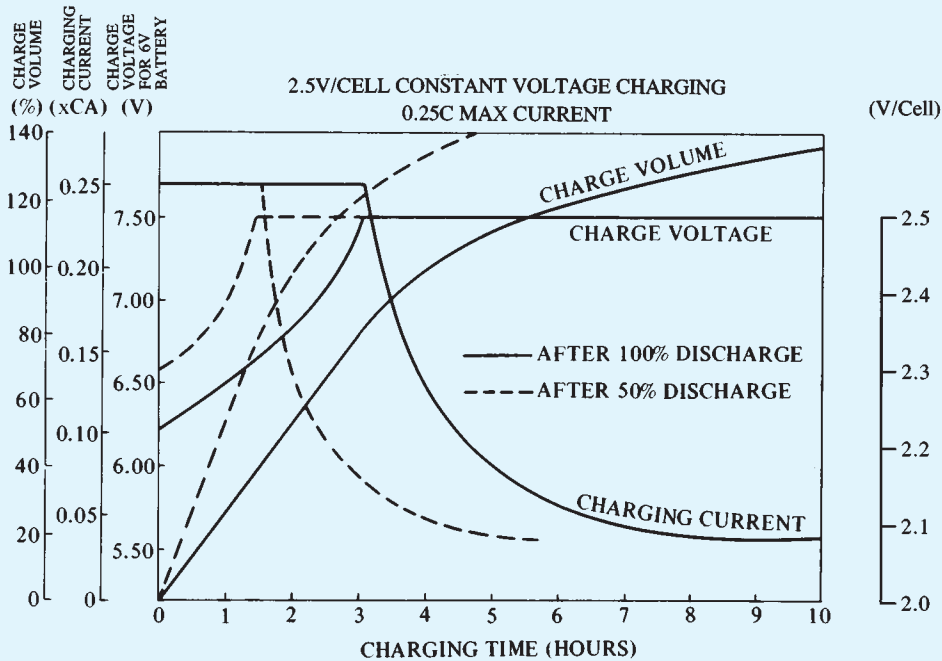
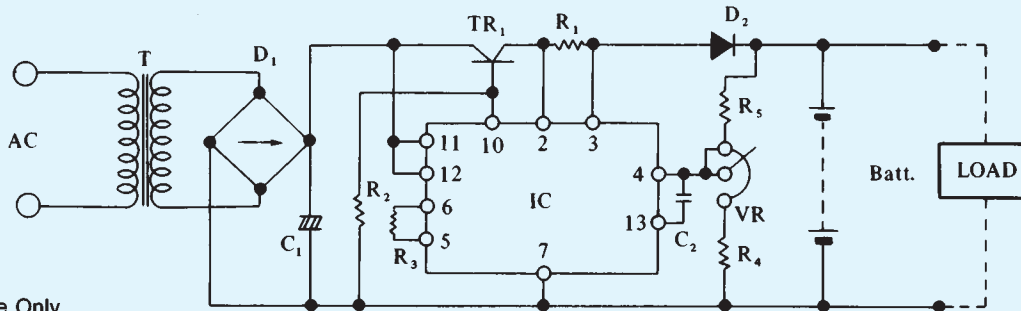

Figure 13. Recommended for overnight charge only.

Figure 14 shows one example of a constant voltage charging circuit. In the circuit, initial charging current is limited by series resistance R_1 .

Figure 14. ONE EXAMPLE OF CONSTANT VOLTAGE CHARGING CIRCUIT



Reference Only.
No Part #'s Available.

■ **Constant-Current Charging**

This charging method is not often utilized for sealed lead-acid batteries, but is an effective method for charging a multiple number of batteries at one time, and/or as an equalizing charge to correct variances in capacity between batteries in a group. Caution should be exercised when charging by constant

current. If the charge is continued at the same rate for an extended period of time after the battery has reached a fully charged state, severe overcharge may occur, resulting in damage to the battery. Figure 15 shows the characteristics of an NP battery under continuous overcharge conditions.

Figure 15. OVERCHARGE CHARACTERISTICS OF NP6-12 UNDER CONTINUOUS OVERCHARGE

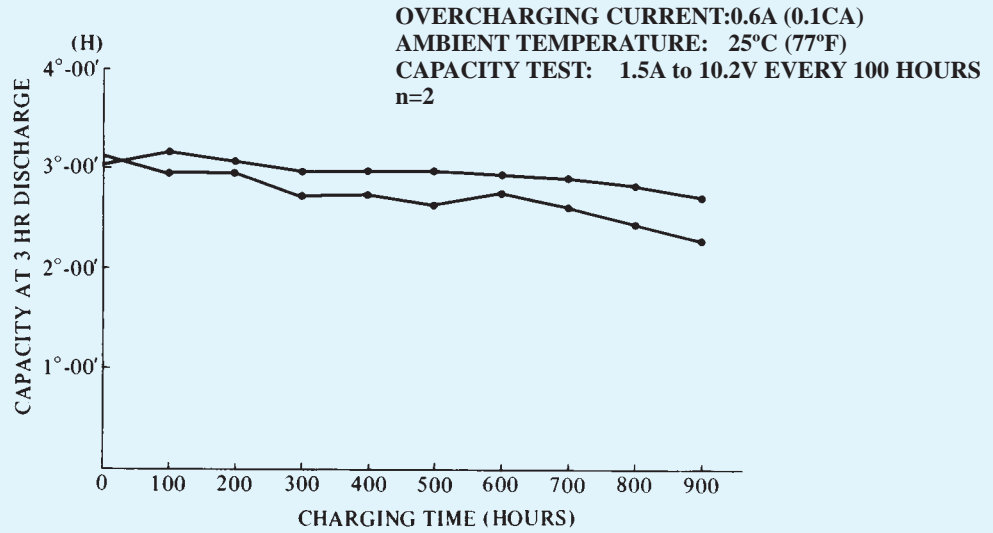
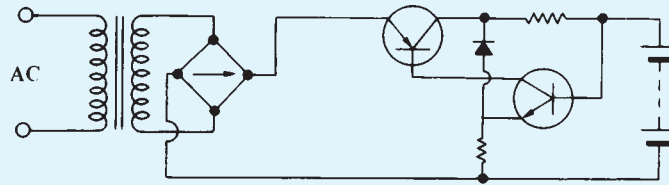

Figure 16 shows a typical constant current charging circuit.

Figure 16. CONSTANT-CURRENT CHARGING CIRCUIT



Reference Only.
 No Part #'s Available.

■ **Taper-Current Charging**

Due to the constant characteristics of taper charging, this method is somewhat abusive of sealed lead-acid batteries and can shorten service life. Consequently, it is not widely recommended. However, because of the simplicity of circuit and subsequent low cost, taper-current charging is extensively used to charge multiple numbers of batteries and/or for cyclic charging. When using a taper charger, it is recommended that the charging time be limited or a charging cut-off circuit be incorporated to prevent overcharge. Please consult the factory for specific recommendations.

In a taper-current charging circuit, the charge current decreases in proportion to the voltage rise. When designing a taper charger, always consider commercial power voltage variations which could create severe charging current fluctuations. In this event, the I R drop will convert to heat. Therefore, heat generated by the circuit should be measured, and if necessary, a heat sink be incorporated in the design. Figure 17 illustrates the characteristics of a typical taper-current charger.

Figure 17. CHARGING CHARACTERISTICS OF A TAPER CHARGER

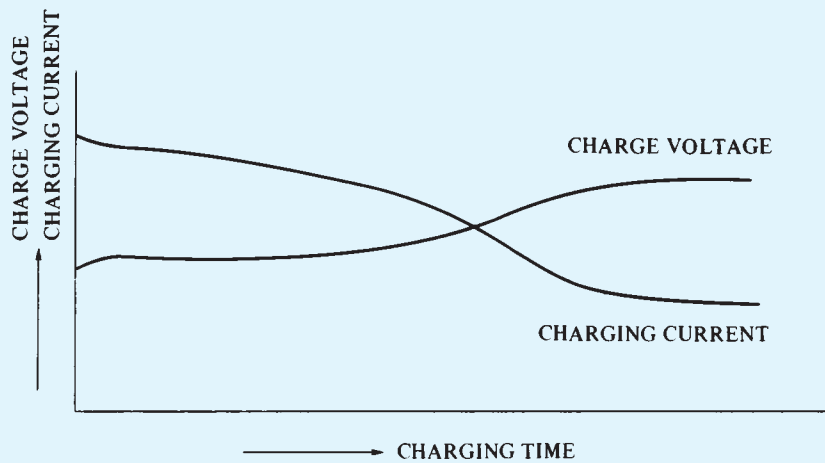
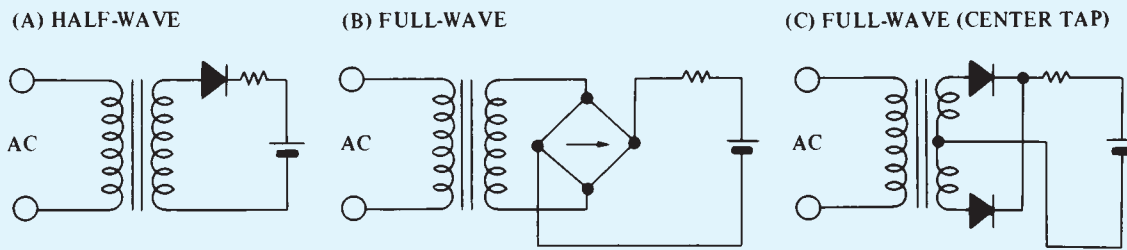

Figure 18. TAPER-CURRENT CHARGING CIRCUITS



Two step constant voltage charging is the recommended method for charging a sealed lead-acid battery in a short period of time, and maintaining the battery in a

fully charged standby or float condition, thereafter. Figure 19 illustrates the characteristics of a two step constant voltage charger.

Figure 19. CHARGING CHARACTERISTICS OF A TWO STEP CONSTANT-VOLTAGE CHARGER

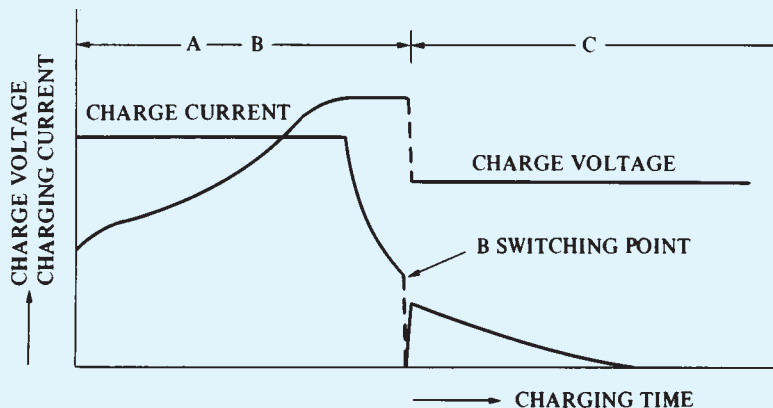

The characteristics shown in Figure 19 are those of a constant voltage, constant current charger. In the initial charging stage, the battery is charged by constant current. The charging voltage rises, as the charge continues, until it reaches 2.45 volts per cell, at which point the charging mode automatically changes to constant voltage charging. During the constant current charging stage (A-B) the charging current which has decreased to point B is sensed, and the charging voltage is switched to the float level of 2.3 volts per cell from the recovery level of 2.45 volts per cell. The switch to constant voltage trickle charging occurs after the battery has recovered approximately 80% of the rated capacity over a given period of time. This charging method is one of the most efficient. The recharge time is minimized during the initial charging stage while the battery is protected from overcharge by

the system switching over to float charge at the switching point B.

Figure 20 illustrates an example of a two step constant voltage, constant current charger. Basically, this is a stabilized power supply circuit, with a current limiting function, utilizing hybrid IC constant voltage elements. The difference between this circuit and the constant voltage circuit shown in Figure 14 is the addition of circuit VD which serves to increase or decrease the output voltage as a function of the variation in output current. In other words, the output voltage is established by changing, with resistor R₆, the potential ratio of the detected voltage of the IC which detects the reduction of voltage at both terminals of resistor R₁.

Figure 20. ONE EXAMPLE OF A TWO STEP CONSTANT-VOLTAGE CONSTANT-CURRENT CHARGING CIRCUIT

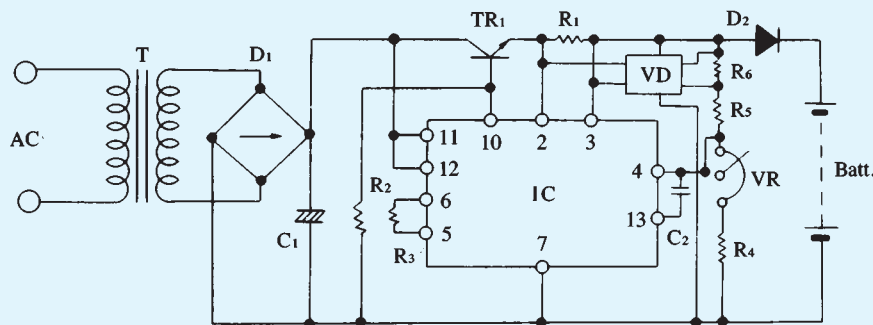

Reference Only.
No Part #'s Available.

When this charging method is used, the output values will be as follows:

Initial Charge Current 0.25CA (to 1.0CA, max.)

Charge Voltage -

1st Step. 2.45v/cell (2.35 to 2.47v/cell, max.)

2nd Step. 2.28v/cell (2.25 to 2.30v/cell, max.)

Switching Current From 1st Step to 2nd Step . . 0.05CA (0.04 to 0.08CA)

Note: This charging method cannot be used in applications where the load and the battery are connected in parallel.

■ Charging Voltage

The charging voltage should be regulated according to the type of service in which the battery will be used. Generally, the following voltages are used:

For standby (float) use 2.25 to 2.30 volts per cell
 For cyclic use 2.35 to 2.47 volts per cell

In a constant voltage charging system, a large amount of current will flow during the initial stage of charging, and decreases as the charging progresses. When charging at 2.30 volts per cell, charging current at the final stage of charging will drop to as little as 0.002CA.

The charge volume shown on the ordinate axis of Figures 8 through 13 indicates the ratio of charged ampere-hours versus the previously discharged ampere-hours. When a battery has been charged up to the level of 100% of the discharged ampere-hours, the electrical

energy stored and available for discharge will be 90%, or more, of the energy applied during charging.

Charging voltage should be regulated in relation to the ambient temperature. When the temperature is higher, the charging voltage should be lower. When the temperature is lower, the charging voltage should be higher. For specific recommendations, please refer to the section on Temperature Compensation on page 21.

Similarly, charged volume (measured in ampere-hours) attainable over time will vary in direct relation to the ambient temperature. The charged volume in a given period of time will be larger at higher temperatures, and smaller at lower temperatures. Figure 21 shows the relationship between charged volume and temperature.

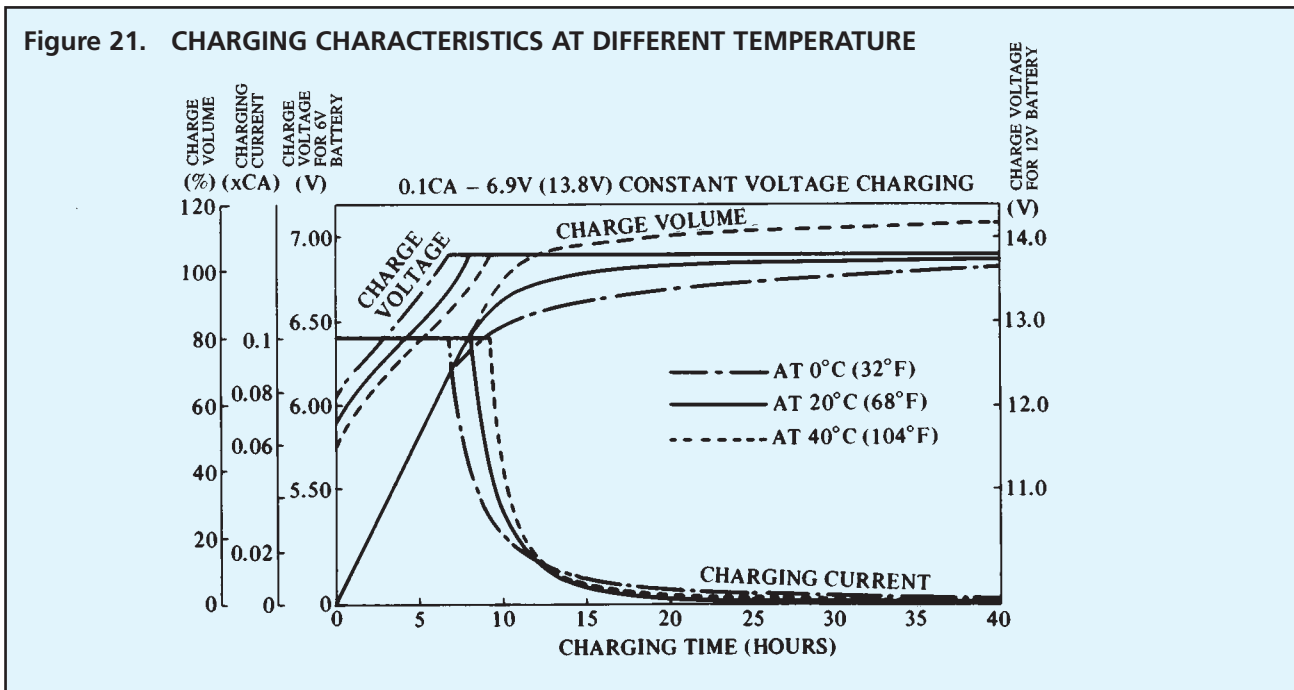

■ Initial Charge Current Limit

A discharged battery will accept a high charging current at the initial stage of charging. High charging current can cause abnormal internal heating which may damage the battery. Therefore, it is recommended that the charging current be normally limited to 0.25CA. However, in standby use, Yuasa NP batteries are designed so that even if the charging current is higher than the recommended limit, they will not accept more than 2CA, and the charging current will be reduced to a relatively small value in a very brief period of time. Therefore, in standby use, no current limit is required. Figure 22 shows current acceptance in NP batteries charged at constant voltage, with no current limit.

When designing a charger, it is recommended that a current limiting function be provided in the charger in order to prevent charger failure due to overheating of the transformer, or other damage resulting from mishandling, i.e., short circuiting or reversing polarity.

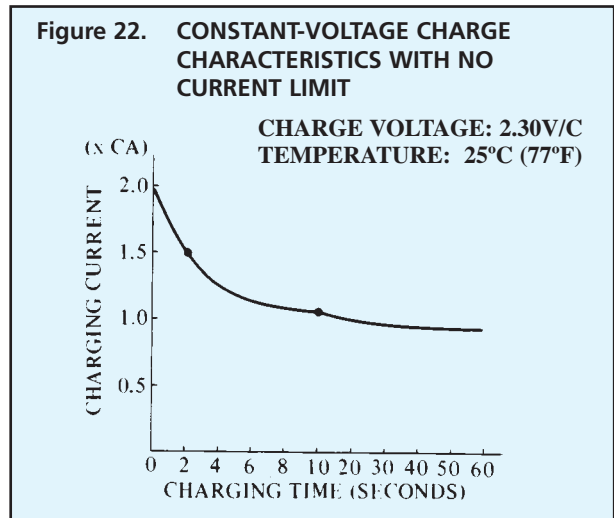

■ Charge Output Regulation and Accuracy

To insure accuracy, when adjusting the output voltage of a constant voltage charger, all adjustments must be made with the charger under load. Adjusting the output voltage with the charger in a "NO LOAD" condition may result in undercharging. The constant voltage range required by a battery is always defined as the voltage range applied to a battery which is fully charged. Therefore, a charger having the output characteristics illustrates in Figure 23, should be

adjusted with the output voltage based on point A. The most important factor in adjusting charger output voltage is the accuracy at point A. Stringent accuracy of 2.25 to 2.30 volts per cell is not required over the entire range of the load. A charger adjusted in accordance with Figure 23 will never damage a battery, even if the charger has the characteristics shown by the broken line in Figure 23.

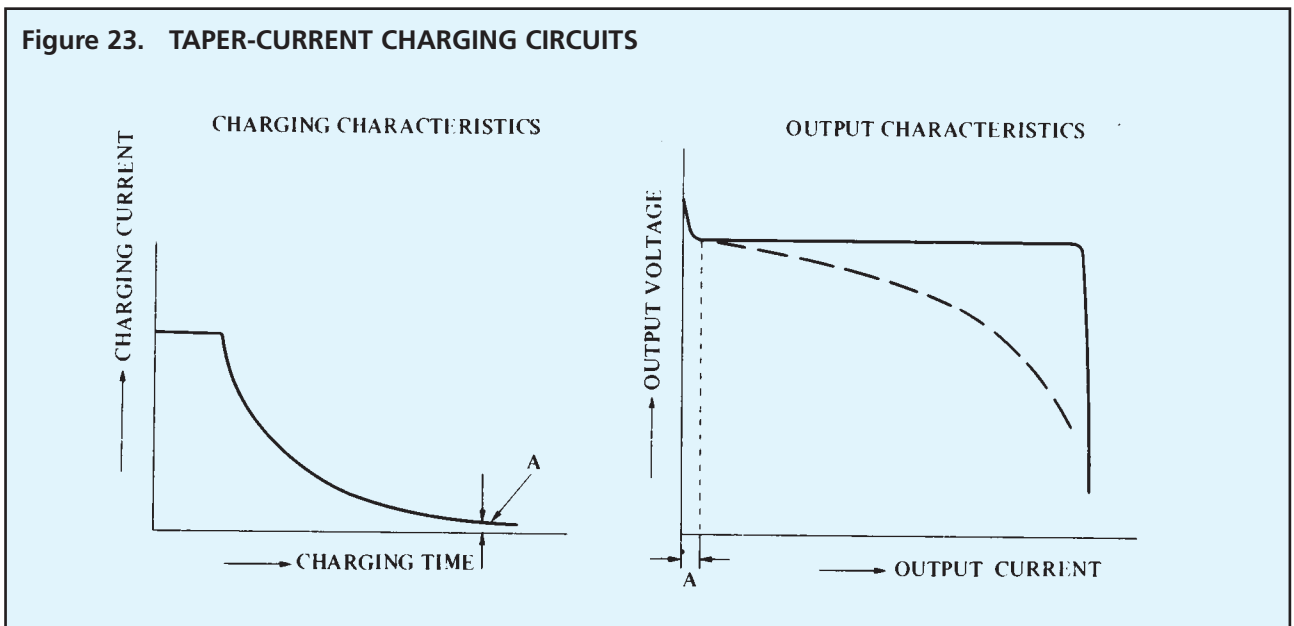

■ Top Charging

Since any battery loses capacity through self-discharge, it is recommended that a "top charging" be applied to any battery which has been stored for a long period of time, prior to putting the battery into service. Excepting conditions in which storage temperature have been abnormally

high, top charging is recommended within the following parameters:

Battery Age	Top Charging Recommendations
Within 6 months after manufacture	4 to 6 hours at constant current of 0.1CA, or 15 to 20 hours at constant voltage of 2.40 volts per cell.
Within 12 months after manufacture	8 to 10 hours at constant current of 0.1CA, or 20 to 24 hours at constant voltage of 2.40 volts per cell.

In order to successfully top charge a battery stored for more than 12 months, the open circuit voltage must be higher than 2.0 volts per cell. In this case, always confirm open circuit voltage prior to attempting top charging.

■ Recovery Charge After Deep Discharge

When a battery has been subjected to deep discharge (commonly referred to as over-discharge), the amount of electricity which has been discharged is actually 1.5 to 2.0 times as great as the rated capacity of the battery. Consequently, a battery which has been over-discharged requires a longer charging period than normal. Please note, as shown in Figure 24 below, that as a result of

internal resistance, charging current accepted by an over-discharged NP battery during the initial stage of charging will be quite small, but will increase rapidly over the initial 30 minutes (approximate) until internal resistance has been overcome, and normal, full recovery charging characteristics resume.

Figure 24. TYPICAL CHARGING CHARACTERISTICS AFTER DEEP DISCHARGE

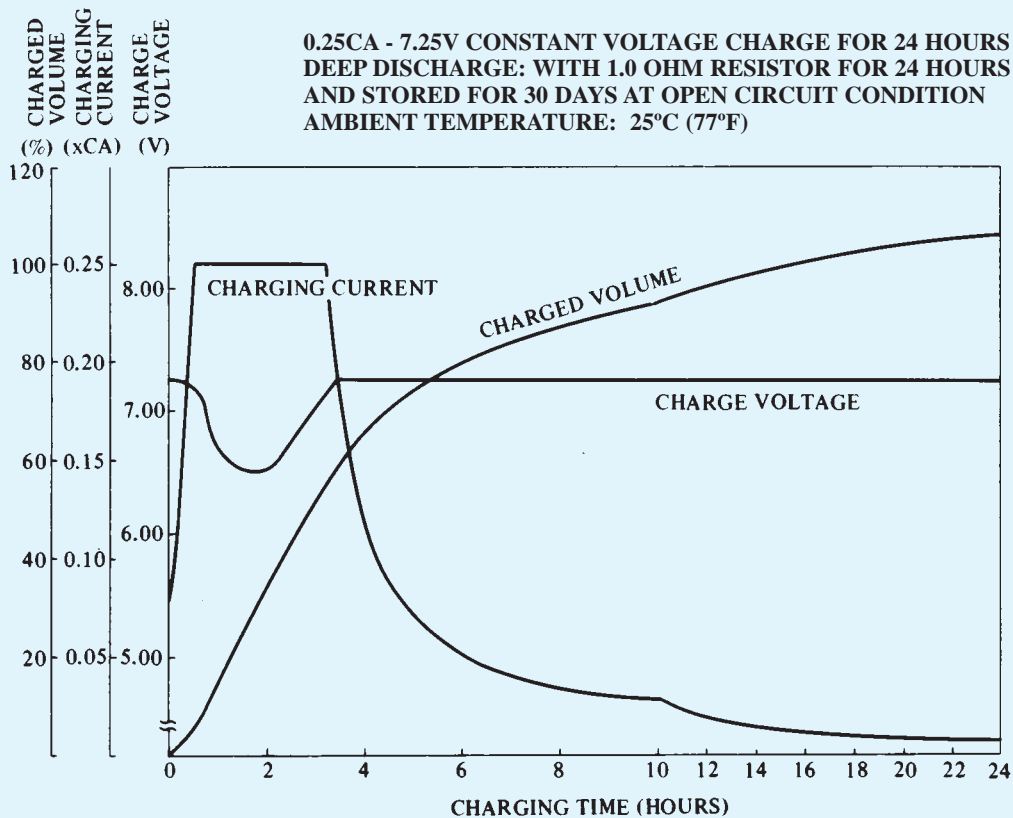

In view of the above, consideration should be given to the fact that if the charging method used is constant voltage in which the charger employs current sensing for either state of charge indication or for reducing voltage (a two step charger), during the initial stage of charging an

over-discharged battery the charger may give a false "full charge" indication, or may initiate charge at a float voltage.

■ Temperature Compensation

As temperature rises, electrochemical activity in a battery increases. Similarly, as temperature falls, electrochemical activity decreases. Therefore, conversely, as temperature rises, charging voltage should be reduced to prevent overcharge, and increased as temperature falls to avoid undercharge. In general, to assure optimum service life, use of a temperature compensated charger is

recommended. The recommended compensation factor for NP batteries is $-3\text{mV}/^\circ\text{C}/\text{Cell}$ (stand by) and $-4\text{mV}/^\circ\text{C}/\text{Cell}$ (cyclic use). The standard center point for temperature compensation is 20°C (68°F).

Figure 25 shows the relationship between temperatures and charging voltages in both cyclic and standby applications.

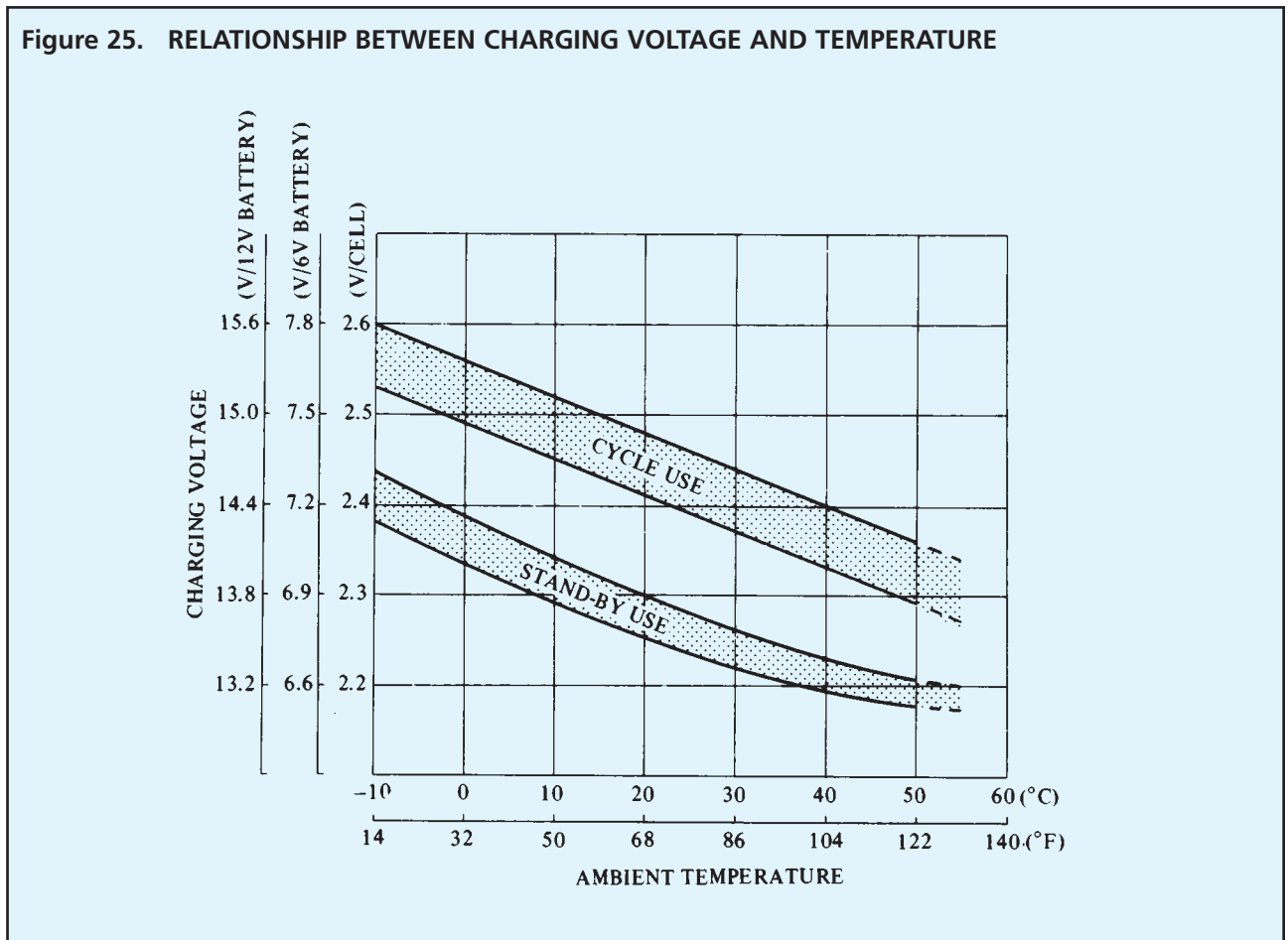

In actual use in indoor applications (5°C to 40°C or 41°F to 104°F), it is not necessary to provide the charger with a temperature compensation function, but it is desirable to set the voltage at the value shown in Figure 25 which corresponds most closely to the average ambient temperature of the battery during service.

When designing a charger equipped with temperature compensation, the temperature sensor must sense only the temperature of the battery. Therefore, consideration should be given to isolating the battery and temperature sensor from other heat generating components of a system.

■ **Charging Efficiency**

The charging efficiency (η) of a battery is expressed by the following formula:

$$\eta = \frac{\text{AH Discharged After Charged}}{\text{AH Delivered To The Battery During Charge}}$$

The charging efficiency varies depending upon the state of charge of the battery, temperature, and charging rate.

Figure 26 illustrates the concept of the state of charge and charging efficiency.

As shown in Figure 27, Yuasa NP batteries exhibit very high charging efficiency, even when charged at low charging rates. It is interesting to note that the charging efficiency of NP sealed lead-acid batteries is superior to that of nickel cadmium batteries even at relatively low charge rates.

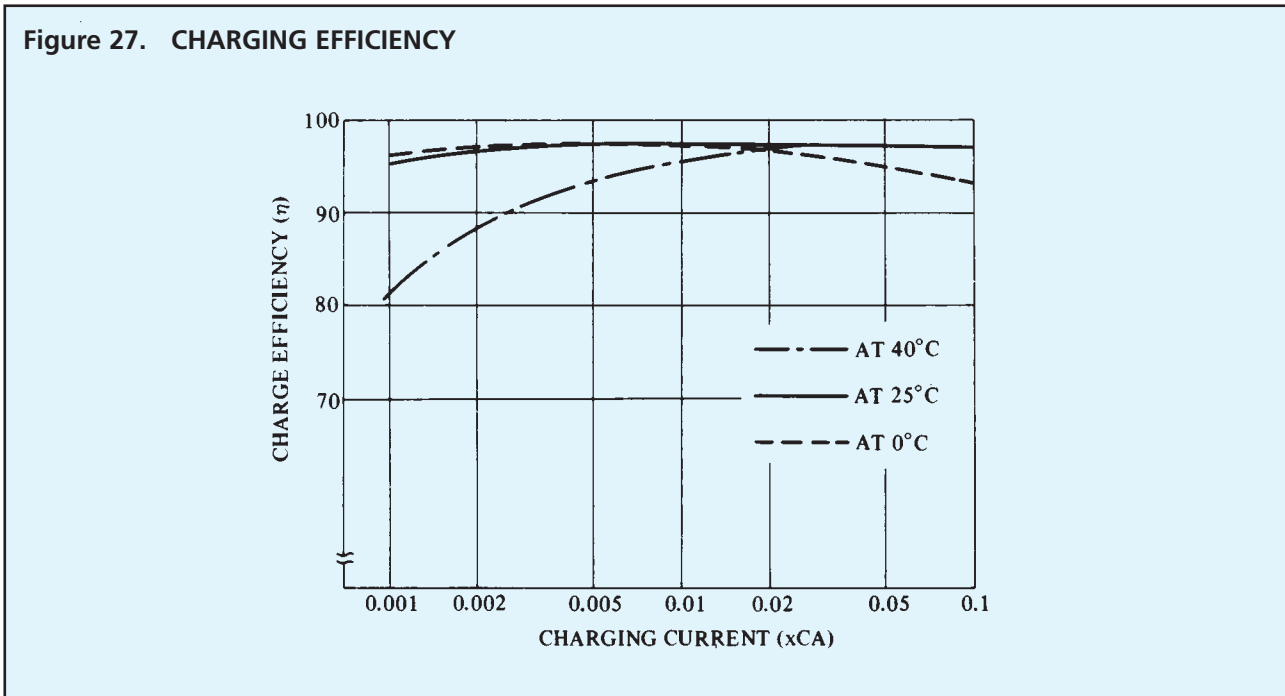
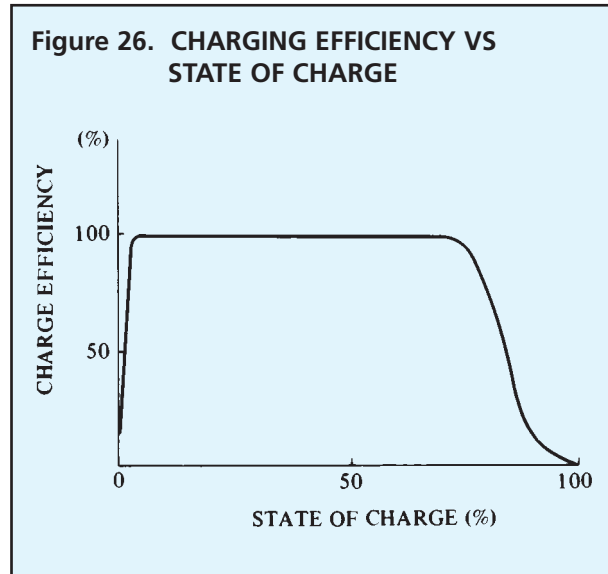

■ Solar Powered Chargers

A battery is an indispensable component of any solar powered system designed for demand-energy use. Since solar cells have inherent constant voltage characteristics, NP batteries can be charged directly from the solar array using a simple diode regulated circuit as shown in Figure 28.

In designing a solar system, consideration should be given to the fact that, in addition to normal periods of darkness, weather conditions may be such that solar energy is limited, or virtually unavailable for long periods of time. In extreme cases, a system may have to operate for 10 to 20 days with little or no power available for charging. Therefore, when selecting the correct battery for a solar application, the capacity should be determined based upon maximum load conditions for the maximum period of time the system may be expected to be without adequate solar input.

In many instances the battery capacity will be 10 to 50 times greater than the maximum output of the solar panels. Under these circumstances, the maximum output of the solar array should be dedicated to charging the battery with no load-sharing or intervening control devices of any kind.

Naturally, in cases where the output of the solar array exceeds the capacity of the battery, and weather conditions are such that the potential for overcharging the battery exists, appropriate regulated charging circuitry between the solar panels and the battery is recommended.

Figure 28. BLOCK DIAGRAM OF A SOLAR SYSTEM

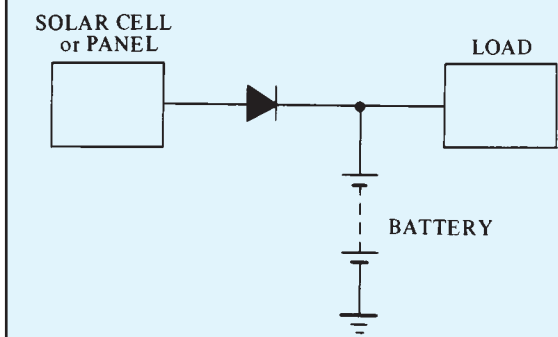

Remote site, or other outdoor applications for solar systems is commonplace. When designing a solar system for this class of application, a great deal of consideration must be given to environmental conditions. For example, enclosures which may be used to house batteries and other equipment may be subject to extremely high internal temperatures when exposed to direct sunlight. Under those conditions, insulating the enclosure and/or treating the surface of the enclosure with a highly reflective, heat resistive material is recommended.

In general, when designing a solar system, consultation with the solar panel manufacturer and battery manufacturer is recommended.

EXPECTED SERVICE LIFE OF NP BATTERIES

■ Cyclic Service Life

There are a number of factors that will effect the length of cyclic service of a battery. The most significant are ambient operating temperature, discharge rate, depth of discharge, and the manner in which the

battery is recharged. Generally speaking, the most important factor is depth of discharge. Figure 29 illustrates the effects of depth of discharge on cyclic life.

Figure 29. CYCLE SERVICE LIFE IN RELATION TO DEPTH OF DISCHARGE NP SERIES

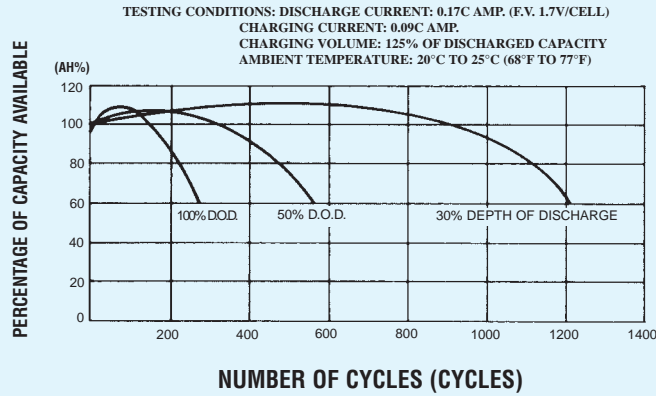

The relationship between the number of cycles which can be expected, and the depth of discharge is readily apparent. In relation to a specified discharge rate, if the application requires a longer cyclic life than is obtainable by selecting the battery capacity according

common practice, select a battery with larger capacity. Thus, at the specified discharge rate over the specified time, the depth of discharge will be shallower and cyclic service life will be longer.

■ Float Service Life

NP batteries are designed to operate in standby (float) service for approximately 5 years, based upon a normal service condition in which float charge voltage is maintained between 2.25 and 2.30 volts per cell in

an ambient temperature of approximately 20°C (68°F). Figure 30 shows the float service life characteristics of NP batteries when discharged once every three (3) months to 100% depth of discharge.

Figure30. FLOAT SERVICE LIFE

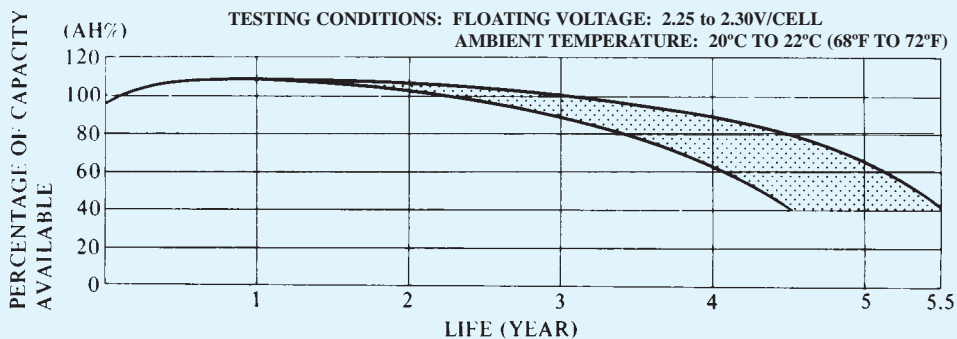

In normal float service, where charging voltage is maintained 2.25 to 2.30 volts per cell, the gases generated inside and NP battery are continually recombined, and return to the water content of the electrolyte. Therefore, electrical capacity is not lost due to “drying up” of the electrolyte. Actually, through the gradual and very slow corrosion of the electrodes, the battery will eventually lose capacity and come to the end of service life. It should be noted that the corrosive process will be accelerated by high ambient operating temperatures and/or

high charging voltage. When designing a float service system, always consider the following:

LENGTH OF SERVICE LIFE WILL BE DIRECTLY EFFECTED BY THE NUMBER OF DISCHARGE CYCLES, DEPTH OF DISCHARGE, AMBIENT TEMPERATURE, AND CHARGING VOLTAGE.

TIPS AND PRECAUTIONS

Yuasa NP Series batteries are truly efficient maintenance free electro-chemical systems and are designed to provide years of trouble free service. Their performance and service life can be greatly maximized by observing the following guidelines.

1. Heat kills batteries. Avoid installation and/or operation in close proximity to heat sources of any kind. While the operating temperature range is -15°C to 50°C , and ideal service life will be realized when the battery is operated in an ambient temperature of 20°C (for cyclic service applications, a range of 5°C to 35°C is recommended).
2. If the battery is to be installed in an air or water tight container, ventilation must be provided. Batteries may generate ignitable gases which must not be contained. Because of this, batteries should not be installed near spark producing equipment.
3. Avoid installing the battery in an atmosphere where organic solvents or adhesives may be present. Do not clean the battery with oils, thinners or similar substances. Use water only. The case and cover of the battery is ABS plastic resin which may suffer damage from these chemicals.
4. Soldering to the battery terminals is NOT recommended. If soldering is unavoidable, it must be accomplished within 3 seconds, using a maximum 100 watt soldering iron.
5. If installed in a heavy vibration or shock application, the battery must be securely fastened with shock absorbing materials.
6. Provide free air space between batteries when more than two are grouped together. The recommended distance is 0.2" to 0.4" (5mm to 10mm).
7. Always wear insulated gloves when handling batteries; especially when series and parallel connecting groups of batteries.
8. When batteries are connected together in a series-parallel arrangement, the inter-connecting cables must be of equal length and resistance to insure equalization of the load.
9. For maximum life expectancy, the R.M.S. ripple current should be regulated to no more than 0.1C (10% of battery's rating).
10. Do not crush, incinerate or dismantle the battery. The electrolyte contains sulfuric acid which can cause serious damage to eyes and skin. Should this occur, flush profusely with water and seek medical attention.
11. Mixing batteries of different capacities, age and/or manufacture is not recommended. Please consult with an application engineer if it is unavoidably necessary.
12. Battery life is dependent on its operating conditions. Please refer to the life curves published in this Applications Manual. These curves represent typical results under optimum operating conditions. Actual life will vary greatly due to variability of these conditions. To obtain optimum battery performance for standby service, Yuasa, Inc. recommends that within five years of use, the NP batteries be replaced.
13. Observe the external appearance of the battery. If, at any time, cracks, deformation or other damage is found on the battery case or cover, or if any leakage of the electrolyte is observed, immediately replace the battery.
Note: If a battery with any irregular appearance as stated above is used continuously, a decrease in capacity, leak age of electrolyte, short circuits and a potential for a smoke and/or fire incident may occur.

GLOSSARY OF TERMS

Active Material	The active electro-chemical materials used in the manufacture of positive and negative electrodes.
Ambient Temperature	The average temperature seen by the battery.
Available Capacity	The capacity from the battery based on its state of charge, rate of discharge, and ambient temperature.
Battery	Two or more cells, series connected together. A single cell is sometimes referred to as a battery.
C-Rate	A current rate expressed in amperes or milliamperes, in direct relation to a battery's ampere hour rating. Ex: 6 Ah rating, 1C = 6 amps; 3C = 18 Amps; 0.05C = 300 milliamps
CA	C Ampere; the C-rate of a battery measured in amperes.
Capacity Fade	Loss of capacity due to inadequate recharging.
Cell	The minimum unit of which a storage battery is composed. Note: The nominal voltage of a single lead acid cell is 2.0 volts.
Closed Circuit Voltage Test	A test method in which the battery is briefly discharged at a constant current while the voltage is measured.
Constant Voltage Charge	A method of charging batteries by applying a fixed voltage and allowing the current to vary. Recommended for sealed lead acid batteries. (Also called constant potential charge).

GLOSSARY OF TERMS (Continued)

Cutoff Voltage	The final voltage of a cell or battery at the end of charge or discharge.
Cycle	A single charge and discharge of a cell or battery.
Discharge Rate	Current taken from a cell or battery and expressed as a fraction of C (Ampere-hour rating of the cell or battery).
End-of-Charge Voltage	The voltage reached by the cell or battery at the end-of-charge, while the charger is still attached.
Electrolyte	Conducts ions in the cell. Lead acid batteries use a sulfuric acid solution.
Energy Density	Ratio of cell or battery energy to weight or volume: watt-hours per pound or per cubic inch.
Gas Absorption	The ability of the negative plate to absorb oxygen gas generated within the battery; the greater this ability, the greater the charge current capability.
High-Rate Discharge	A very rapid discharge of the battery. Normally in multiples of C (Ampere-hour rating of the cell or battery).
Internal Impedance	The resistive value of the battery to an AC current, expressed in ohms. Normally measured at 1 khz at full charge.
Low Voltage Cutoff	A sensing device designed to end discharge at a predetermined voltage level.
Nominal Capacity	The nominal value of rated capacity. In sealed lead acid batteries, nominal capacity is usually measured at the 20 hour rate.
Nominal Voltage	The nominal value of rated voltage. In lead acid batteries, nominal voltage is 2 volts per cell.
Open Circuit Voltage	The measured voltage of the cell or battery without a load attached.
Overcharge	The continuous charging of a cell after it achieves 100% of capacity. Battery life is reduced by prolonged over charging.
Parallel Connection	Connection of a group of batteries by inter-connecting all terminals of the same polarity, thereby increasing the capacity of the battery group. (Note: Differing brands and/or capacities should not be connected together).
Primary Cell	A cell which can be discharged only once. Example: Manganese zinc and alkaline.
Rated Capacity	The capacity of the cell expressed in ampere hours. Commonly, a constant current for a designated number of hours to a specified depth of discharge at room temperature.
Resealable Safety Vent	The safety device built into the cell to allow the release of excess gases and prevent case rupture.
Secondary Battery	A battery which can be charged and discharged repeatedly. Example: Lead acid and nickel cadmium batteries.
Self Discharge	The loss of capacity of a battery while in stored or unused condition without external drain.
Separator	The materials which separate the electrodes. In a sealed lead acid battery, they are usually constructed of micro-porous glass fiber and additionally serve to retain the electrolyte.
Series Connection	Connection of a group of batteries by interconnecting all terminals of the opposite polarity, thereby increasing the voltage of the battery group. (Note: The same rule applies as with parallel connections).
Service Life	Expected life of a battery expressed in the number of total cycles or years of standby service to a designated remaining percentage of original capacity.
Shelf Life	The maximum period of time a battery can be stored under specific conditions, without supplementary charging.
Standby Service	A general term for an application in which the battery is maintained in a fully charged condition by trickle or float charging and always ready for use.
Trickle Charge	Continuous charging by means of a small current designed to compensate for self discharge in an unloaded battery.
Voltage Cutoff	A sensing device used to terminate a charge or discharge when the battery reaches a predetermined voltage level.

LIMITED WARRANTY:

Each Yuasa NP Series battery which is sold is warranted against defects in workmanship and materials for a period of one year from the date of manufacture. Under this warranty, our obligation will be limited to the repair or replacement of the battery. Such repair or replacement will be FOB our warehouse in City of Industry, California or other designated location that Yuasa, Inc. may designate. Such repair or replacement will be made only after our examination determines that said battery is defective in material and/or workmanship. We exempt from any warranty claims and any battery which has been subjected to misuse, abuse, altered, or any battery that may have been repaired or attempted to be repaired by other than Yuasa, Inc.

THIS WARRANTY MADE IN LIEU OF ALL OTHER WARRANTIES WITH RESPECT TO THE PRODUCT COVERED HEREBY AND THERE ARE NO OTHER WARRANTIES, WHETHER EXPRESSED OR IMPLIED, OR MERCHANTABILITY OR OTHERWISE EXCEPT THE WARRANTY EXPRESSLY STATED HEREIN. THE REMEDY SET FORTH HEREIN SHALL BE THE SOLE EXCLUSIVE REMEDY OF ANY PURCHASER WITH RESPECT TO ANY DEFECTIVE PRODUCT, UNDER NO CIRCUMSTANCES SHALL WE BE LIABLE FOR ANY INJURY, LOSS, DAMAGE, OR EXPENSE SUFFERED OR INCURRED WITH RESPECT TO ANY DEFECTIVE PRODUCT.



When ordering new batteries, also remember the need to properly dispose (recycle) your old lead-acid batteries.

Most federal and state regulations require lead-acid batteries be recycled. Yuasa, Inc's nationwide service organization can arrange pickup, transportation, and recycling to any one of our company affiliated smelters. Call 1-800-972-7372 for more information.

NOTES

NOTES



Eastern Regional Office: (201) 964-0118 (800) 962-1287

Western Regional Office: (562) 949-4266 (800) 423-4667

Corporate Office: P.O. Box 14145, Reading, PA 19612-4145

fax: (610) 372-8613

Visit us on the web at: www.yuasastationary.com

Please check our website for literature updates