

POWER *PS* SONIC

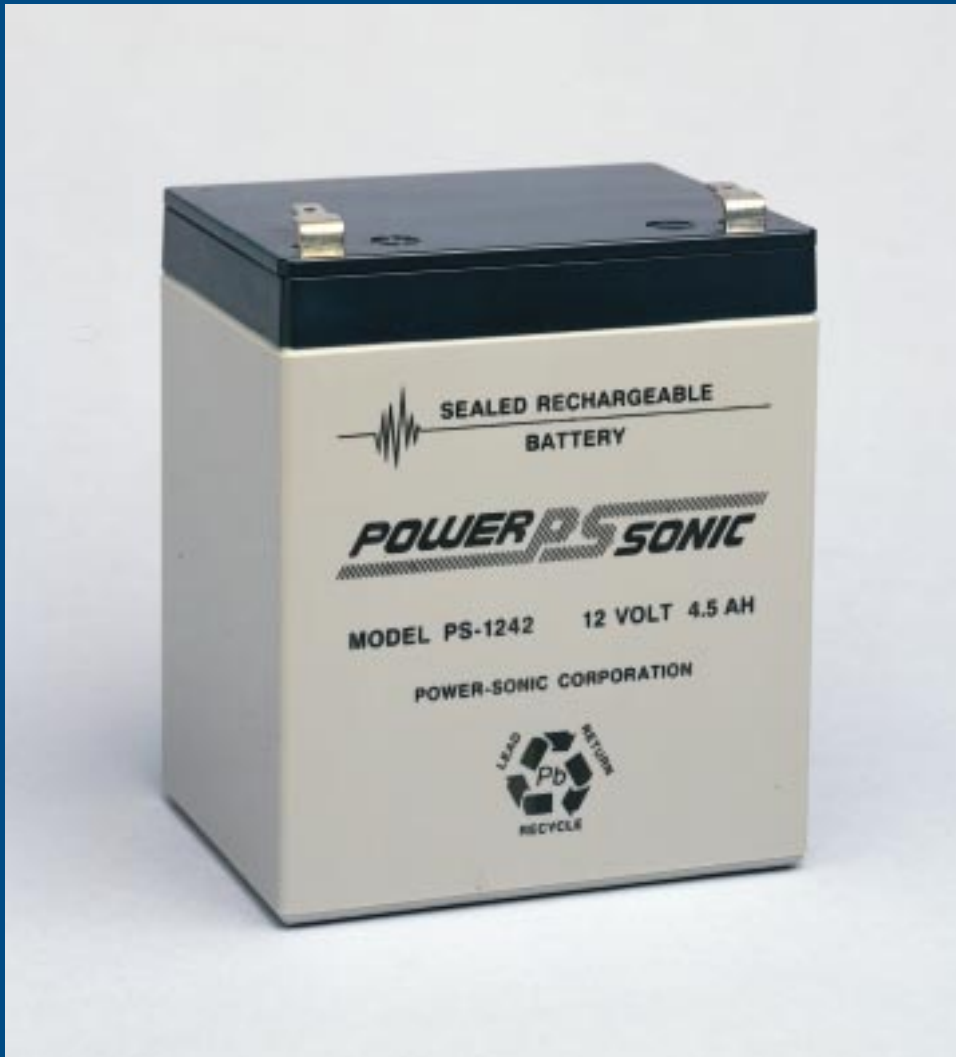

SEALED LEAD-ACID BATTERIES

TECHNICAL HANDBOOK

FEATURES

Sealed/Maintenance-Free

The valve regulated, spill-proof construction of the Power-Sonic battery allows trouble-free, safe operation in any position. There is no need to add electrolyte, as gases generated during over-charge are recombined in a unique "oxygen cycle."

Long Shelf Life

A low self-discharge rate permits storage of fully charged batteries for up to a year at room temperature before charging is required. Lower storage temperatures enhance shelf life characteristics even further.

Design Flexibility

Batteries may be used in series and/or parallel to obtain choice of voltage and capacity. Due to recent design breakthroughs, the same battery may be used in either cyclic or standby applications. Over 50 models are available to choose from.

Deep Discharge Recovery

Special separators, advanced plate composition, and a carefully balanced electrolyte system have greatly improved the ability of recovering from excessively deep discharge.

Economical

The high watt-hour per dollar value is made possible by the materials used in a sealed lead-acid battery: they are readily available and low in cost.

Easy Handling

No special handling precautions or shipping containers — surface or air — are required due to the leak-proof construction. Classified as non-hazardous commodity.

Compact

Power-Sonic batteries use state of the art design, high grade materials, and a carefully controlled plate-making process to provide excellent output per cell. The high energy density results in superior power/volume and power/weight ratios.

High Discharge Rate

Low internal resistance allows discharge currents of up to ten times the rated capacity of the battery. Relatively small batteries may thus be specified in applications requiring high peak currents.

Wide Operating Temperature Range

Power-Sonic batteries may be discharged over a temperature range of -40°C to $+60^{\circ}\text{C}$ (-40°F to $+140^{\circ}\text{F}$) and charged at temperatures ranging from -20°C to $+50^{\circ}\text{C}$ (4°F to $+122^{\circ}\text{F}$).

Rugged Construction

The high impact resistant battery case is made either of non-conductive ABS plastic or styrene. Large capacity batteries frequently have polypropylene cases. All of these case materials impart great resistance to shock, vibration, chemicals and heat.

Long Service Life

Under normal operating conditions, four or five years of dependable service life can be expected in stand-by applications, or between 200-1000 charge/discharge cycles depending on average depth of discharge.



CONSTRUCTION

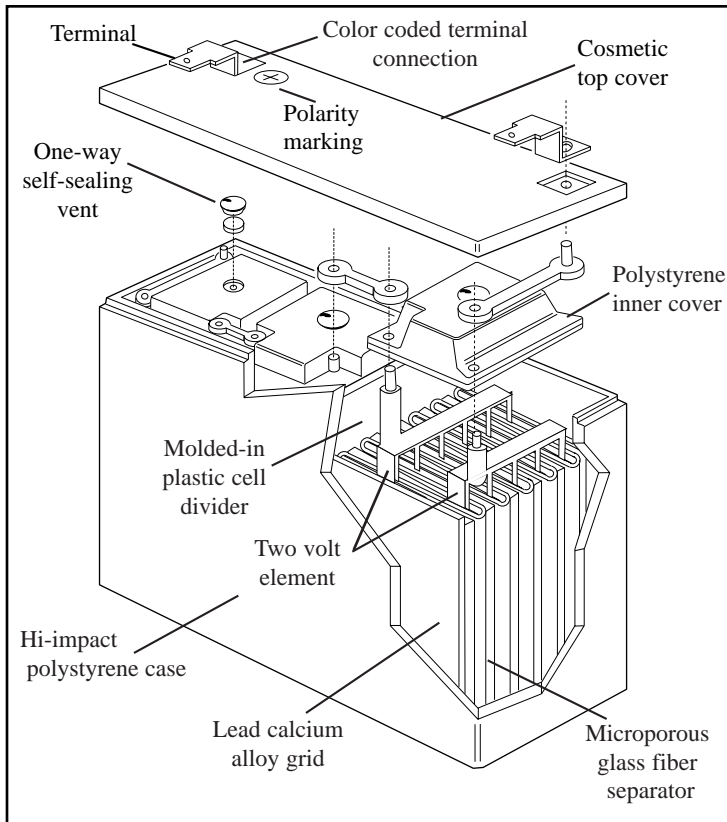

Figure 1

Plates (Electrodes)

Plate construction is the key to producing a good battery. Recognizing this, Power-Sonic utilizes the latest technology and equipment to cast grids from a lead-calcium alloy free of antimony. The small amount of calcium and tin in the grid alloy imparts strength to the plate and guarantees durability even in extensive cycle service. Lead oxide paste is added to the grid to form the electrically active material. In the charged state, the negative plate paste is pure lead and that of the positive lead oxide. Both of these are in a porous or spongy form to optimize surface area and thereby maximize capacity.

Separators

Power-Sonic separators are made of woven glass fiber cloth with high heat and oxidation resistance. The material further offers superior electrolyte absorption and retaining ability, as well as excellent ion conductivity.

Electrolyte

Immobilized dilute sulfuric acid: H_2SO_4 .

Container

Case material is either ABS, a high-impact proof plastic resin, styrene, or a polypropylene-polyethylene copolymer with resistance to chemicals and flammability.

Leakproof Design & Operational Safety

Power-Sonic batteries have been approved for shipment by air, both by D.O.T. and I.A.T.A.. U.L.'s component recognition program for emergency lighting and power batteries lists Power-Sonic under file number MH 20845.

Terminals

Depending on the model, batteries come either with AMP Faston type terminals made of tin plated brass, post type terminals of the same composition with threaded nut and bolt hardware, or heavy duty flag terminals made of lead alloy. A special epoxy is used as sealing material surrounding the terminals.

Relief Valve

In case of excessive gas pressure build-up inside the battery (usually caused by abnormal charging) the relief valve will open and relieve the pressure. The one-way valve not only ensures that no air gets into the battery where the oxygen would react with the plates causing internal discharge, but also represents an important safety device in the event of excessive overcharge. Vent release pressure is between 2-6 psi; the seal ring material is neoprene rubber.

Case Sealing

Depending on model, the case sealing is tongue and groove with polyurethane, epoxy, or heat seal.

THEORY OF OPERATION

The basic electrochemical reaction equation in a lead-acid battery can be written as follows:

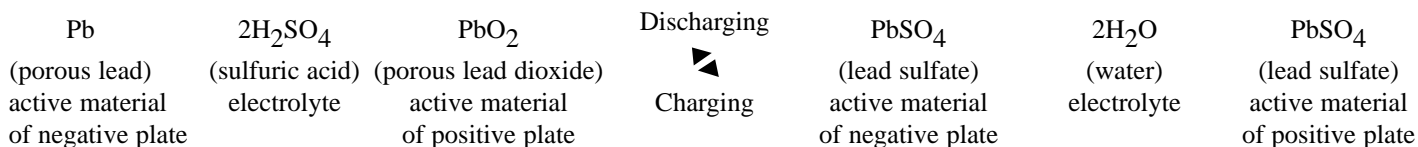

Discharge

During the discharge portion of the reaction, lead dioxide (positive plate) and lead (negative plate) react with sulfuric acid to create lead sulfate, water and energy.

Charge

During the recharge phase of the reaction, the cycle is reversed: the lead sulfate and water are electro-chemically converted to lead, lead oxide and sulfuric acid by an external electrical charging source.

Oxygen Recombination

To produce a truly maintenance-free battery, it is necessary that gases generated during overcharge are recombined in a so-called “oxygen cycle”. Should oxygen and hydrogen escape, a gradual drying out would occur, eventually affecting capacity and battery life. During charge, oxygen is generated at the positive and reacts with and partially discharges the sponge lead of the negative. As charging continues, this oxygen recombines with the hydrogen being generated by the negative, forming water. The water content of the electrolyte thus remains unchanged unless the charging rate is too high.

In case of rapid generation of oxygen gas exceeding the absorbing capacity of the negative plate, the pressure relief valve will open to release excessive gas.

Deep Discharge

The Power-Sonic battery is protected against cell shorting by the addition of a buffering agent that insures the presence of acid ions even in a fully discharged state. The need for expensive circuitry in the design of a system to prevent deep discharge and possible cell shorting is thereby reduced considerably.

Power-Sonic defines “deep discharge” as one that allows the battery voltage under load to go below the cut-off (or “final”) voltage of a full discharge. The recommended cutoff voltage varies with the discharge rate for a 6 volt battery, for example, it is 5.25V at the 20-hour (0.05C) rate, 5.10V at the 4-hour (0.2C) rate, and 4.5V at the 1/2- hour(1.0C) rate.

It is important to note that deep discharging a battery at high rates for short periods is not nearly as severe as discharging a battery at low rates for long periods of time. To clarify, let’s, analyze two examples:

- Battery A is discharged at the 1C rate to zero volts. “C” for a 4 AH battery, for example, is 4 amps. Full discharge is reached after about 30 minutes when the battery voltage drops to 1.5V/cell. At this point, only 50% of rated capacity has been discharged (1C amps x 0.5 hrs = 0.5C Amp. Hrs.) Continuing the discharge to zero volts will bring the total amount of discharged ampere-hours to approximately 75% because the rapidly declining voltage quickly reduces current flow to a trickle. The battery will recover easily from this type of deep discharge.
- Battery B is discharged at the 0.01C rate to zero volts. 0.01C for a 4 AH battery is 40mA. Full discharge is reached after 100+ hours when the terminal voltage drops to 1.75 V/cell. At this point, the battery has already delivered 100% of its rated capacity (0.01 x 100 hrs = 1C Amp. Hrs.). Continuing the discharge to zero volts will keep the battery under load for another 4-5 days(!), squeezing out every bit of stored energy.

This type of “deep” discharge is severe and is likely to damage the battery. The sooner a severely discharged battery is recharged, the better its chances to fully recover.

CAPACITY

The capacity of a battery is the total amount of electrical energy available from a fully charged cell or cells. Its value depends on the discharge current, the temperature during discharge, the final (cut-off) voltage and the general history of the battery.

Capacity, expressed in ampere-hours (AH) is the product of the current discharged and the length of discharge time. The rated capacity (C) of a Power-Sonic battery is measured by its performance over 20 hours of constant current discharge at a temperature of 68°F (20°C) to a cutoff voltage of 1.75 volts.

As an example, Model PS-610, with a rated capacity of 1AH will deliver 50 mA (1/20 of 1AH, or 0.05C) for 20 hours before the voltage drops from 6.45 to 5.25 volts.

By cycling the battery a few times or float charging it for a month or two, the highest level of capacity development is achieved. Power-Sonic batteries are fully charged before leaving the factory, but full capacity is realized only after the battery has been cycled a few times or been on float charge for some time.

The table in *Figure 2* shows capacities for various multiples of the 20-hour discharge current.

Rated Capacity	@ 0.05C rate (20 Hr. Rate.)		@0.1C rate (9 Hr. Rate)		@0.2C rate (4 Hr. Rate)		@0.5C rate (1.3 Hr. Rate)		@1C rate (33 Min. Rate)		@2C rate (12 Min. Rate)		@3C rate (7.2 Min. Rate)	
	Current Amps.	Capacity Amp. Hrs	Current Amps.	Capacity Amp. hrs.	Current Amps.	Capacity Amp.Hrs	Current Amps.	Capacity Amp. Hrs.	Current Amps.	Capacity Amp. hrs.	Current Amps.	Capacity Amp. Hrs.	Current Amps.	Capacity Amp. Hrs.
0.5AH	0.025	0.50	0.05	0.45	0.10	0.40	0.25	0.325	0.50	0.28	1.00	0.20	1.50	0.18
0.8AH	0.04	0.80	0.08	0.72	0.16	0.64	0.40	0.52	0.80	0.44	1.60	0.32	2.40	0.29
1.0AH	0.05	1.00	0.10	0.90	0.20	0.80	0.50	0.65	1.00	0.56	2.00	0.40	3.00	0.36
1.3AH	0.065	1.30	0.13	1.17	0.26	1.04	0.65	0.845	1.30	0.715	2.60	0.52	3.90	0.47
2.3AH	0.115	2.30	0.23	2.07	0.46	1.84	1.15	1.495	2.30	1.288	4.60	0.92	6.90	0.83
3.0AH	0.15	3.00	0.30	2.70	0.60	2.40	1.50	1.95	3.00	1.65	6.00	1.20	9.00	1.08
3.2AH	0.16	3.20	0.32	2.88	0.64	2.56	1.60	2.08	3.20	1.76	6.40	1.28	9.60	1.15
4.5AH	0.22	4.40	0.45	4.05	0.90	3.60	2.25	2.92	4.5	2.47	9.00	1.80	13.50	1.62
5.0AH	0.25	5.00	0.50	4.50	1.00	4.00	2.50	3.25	5.00	2.80	10.00	2.00	15.00	1.80
6.5AH	0.325	6.50	0.65	5.85	1.30	5.20	3.25	4.23	6.50	3.64	13.00	2.60	19.50	2.34
7.0AH	0.35	7.00	0.70	6.30	1.40	5.60	3.50	4.55	7.00	3.85	14.00	2.80	21.00	2.52
8.0AH	0.40	8.00	0.80	7.20	1.60	6.40	4.00	5.20	8.00	4.48	16.00	3.20	24.00	2.88
9.0AH	0.45	9.00	0.90	8.10	1.80	7.20	4.50	5.85	9.00	5.04	18.00	3.60	27.00	3.24
10.0AH	0.50	10.00	1.00	9.00	2.00	8.00	5.00	6.50	10.00	5.60	20.00	4.00	30.00	3.60
12.0AH	0.60	12.00	1.20	10.80	2.40	9.60	6.00	7.80	12.00	6.72	24.00	4.80	36.00	4.32
18.0AH	0.90	18.00	1.80	16.20	3.06	14.40	9.00	11.70	18.00	9.90	36.00	7.20	54.00	6.48
20.0AH	1.00	20.00	2.00	18.00	4.00	16.00	10.00	13.00	20.00	11.20	40.00	8.00	60.00	7.20
26.0AH	1.30	26.00	2.60	23.40	5.20	20.80	13.00	16.90	26.00	14.30	52.00	10.40	78.00	9.36
28.0AH	1.40	28.00	2.80	25.20	5.40	21.60	14.00	18.20	28.00	15.40	54.00	10.88	84.00	10.08
33.0AH	1.65	33.00	3.30	29.70	6.60	26.40	16.50	21.45	33.00	18.15	66.00	13.20	99.00	11.88
40.0AH	2.00	40.00	4.00	36.00	8.00	32.00	20.00	26.00	40.00	22.40	80.00	16.00	120.00	14.40
55.0AH	2.75	55.00	5.50	49.50	11.00	44.00	27.50	35.75	55.00	30.25	110.00	22.00	165.00	19.80
60.0AH	3.00	60.00	6.00	54.00	12.00	48.00	30.00	39.00	60.00	33.60	120.00	24.00	180.00	21.60
75.0AH	3.75	75.00	7.50	67.50	15.00	60.00	37.50	48.75	75.00	41.25	150.00	30.00	225.00	27.00
80.0AH	4.00	80.00	8.00	72.00	16.00	64.00	40.00	52.00	80.00	44.80	160.00	32.00	240.00	28.80
100.0 AH	5.00	100.00	10.00	90.00	20.00	80.00	50.00	65.00	100.00	55.00	200.00	40.00	300.00	36.00

Figure 2

When a battery discharges at a constant rate, its capacity changes according to the amperage load. Capacity increases when the discharge current is less than the 20-hour rate and decreases when the current is higher.

Figure 3 shows capacity curves for major Power-Sonic battery models with different ampere-hour ratings. Amperage is on the horizontal scale and the time elapsed is on the vertical scale; the product of these values is the capacity.

Proper battery selection for a specific application can be made from this graph if the required time and current are known. For example, to determine the proper capacity of a battery providing 3 amps for 20 minutes, locate the intersection of these values on the graph. The curve immediately above that point represents the battery which will meet the requirement.

CAPACITY VARIATION BY CURRENT LOAD

Figure 3

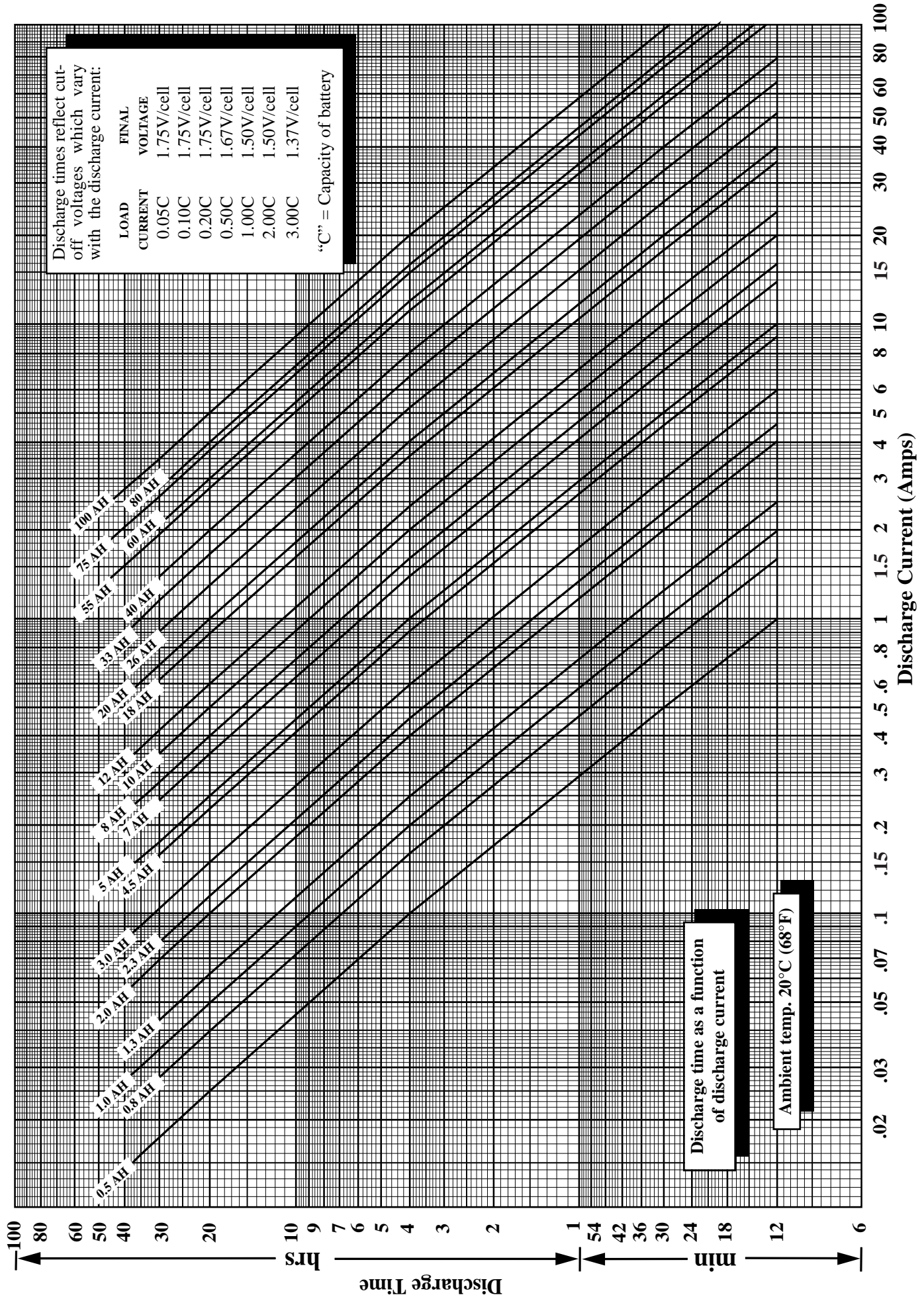

PERFORMANCE DATA

Discharge

During discharge the voltage will decrease. The graphs in *Figure 4* illustrate this for different discharge rates and ambient temperatures. “C” is the rated capacity of a battery: “C” for Model PS-610 (6V - 1AH) is 1AH. By convention, rating of nearly all sealed-lead acid batteries, including Power-Sonic, is based on a 20-hour (0.05C) discharge rate .

An important feature of Power-Sonic batteries is shown in the discharge curves; namely, the voltage tends to remain high and almost constant for a relatively long period before declining to an end voltage.

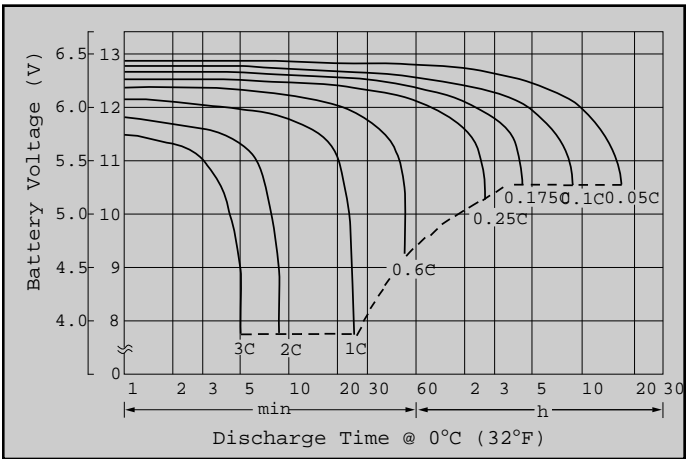
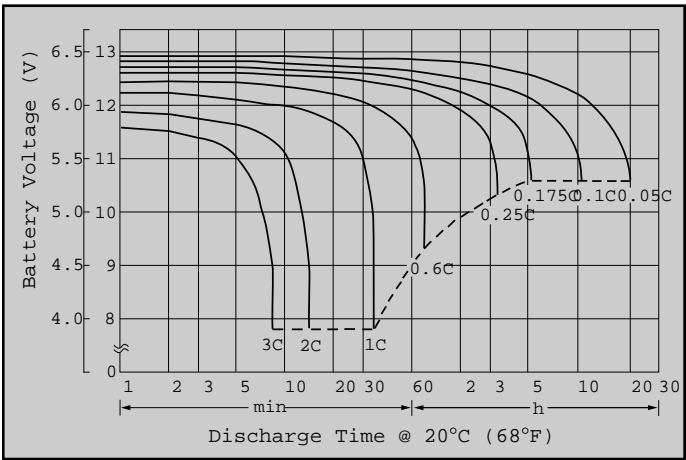

Figure 4: Characteristic Discharge Curves

Open-Circuit Voltage

Open circuit voltage varies according to ambient temperature and the remaining capacity of the battery. Generally, open circuit voltage is determined by the specific gravity of the electrolyte. Discharging a battery lowers the specific gravity. Consequently, it is possible to determine the approximate remaining capacity of a battery from the terminal voltage.

The open circuit voltage of a Power-Sonic battery is 2.15 V/cell when fully charged and 1.94 V/cell when com-

pletely discharged.

As seen in *Figure 4*, under load, the battery can deliver useful energy at less than 1.94 V/cell, but after the load is removed the open circuit voltage will “bounce back” to voltages shown in *Figure 5*, dependent upon residual capacity.

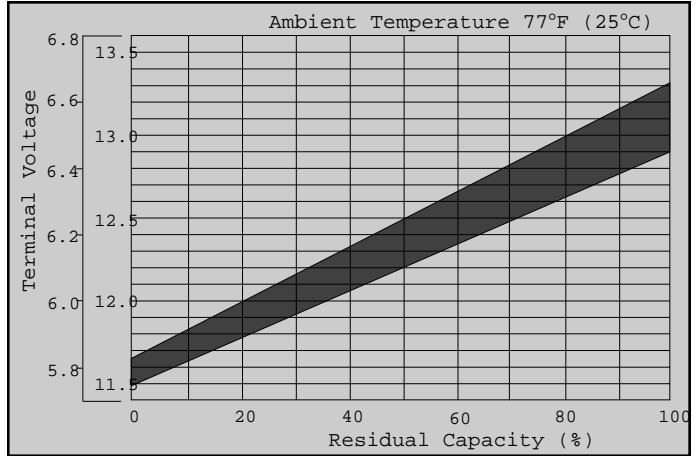

Figure 5: Open-Circuit Voltage Characteristics

Temperature

Actual capacity is a function of ambient temperature and rate of discharge. At 68°F (20°C) rated capacity is 100%. The capacity increases slowly above this temperature and decreases as the temperature falls. Even at -40°F (-40°C), however, the Power-Sonic battery will still function at better than 30% of its rated capacity when discharged at the 20-hour rate (0.05C). At any ambient temperature, the higher the rate of discharge, the lower the available capacity. This relationship is shown in *Figure 6*.

Power-Sonic batteries may be discharged at temperatures ranging from -40°F to 140°F (-40°C to 60°C) and charged at temperatures from -4°F to 122°F (-20°C to 50°C).

While raising ambient temperature increases capacity, it also decreases useful service life. It is estimated that battery life is halved for each 10°C above normal room temperature.

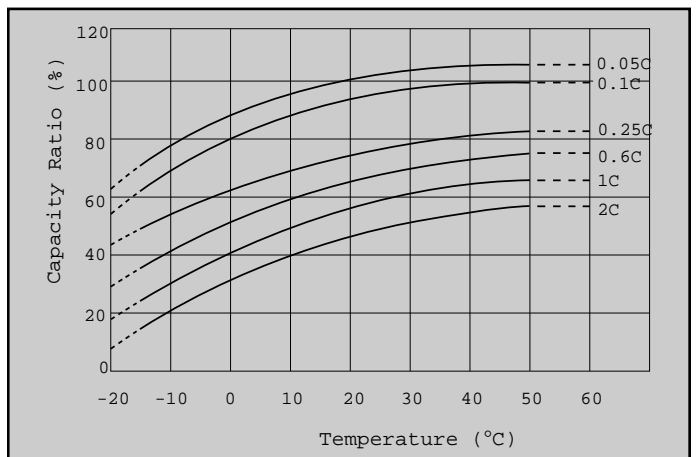

Figure 6: Effect of Temperature on Capacity

PERFORMANCE DATA

Figure 7 shows the relationship between current and discharge time for different ambient temperatures.

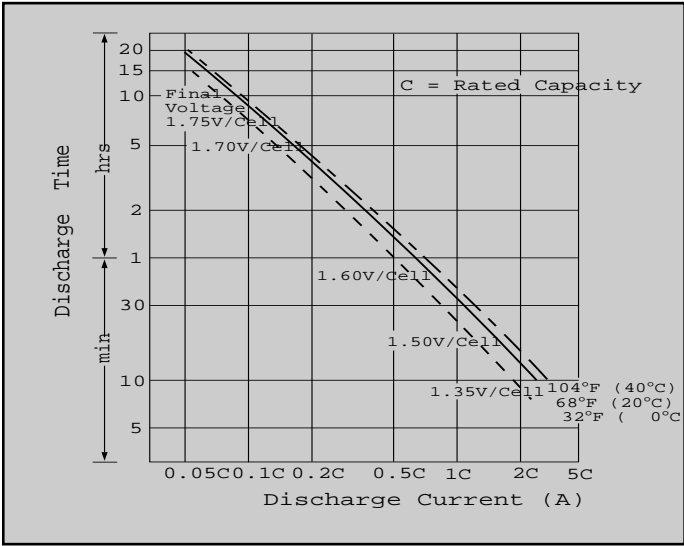

Figure 7: Discharge Time vs. Discharge Current

Shelf Life & Storage

Low internal resistance and special alloys in the electrodes assure a low self discharge rate and, consequently, a long shelf life. If kept at 68°F (20°C), about 60-70% of the nominal capacity remains after one year of storage. One recharge per year is sufficient to maintain the original capacity of a battery not in use.

The rate of self discharge varies with the ambient temperature. At room temperature it is about 3% per month. At low temperatures it is nearly negligible, at higher ambient temperatures self discharge increases.

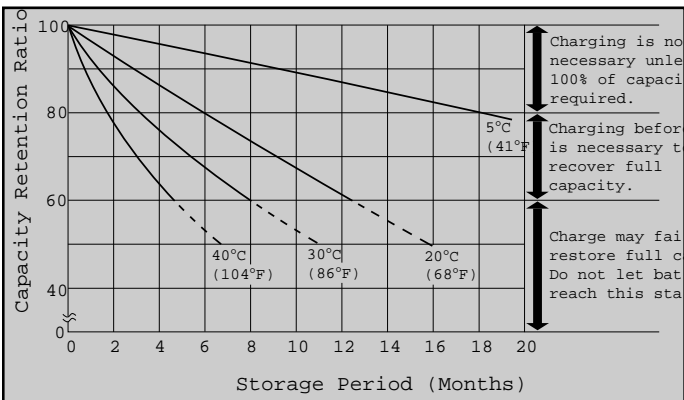

Figure 8: Self Discharge Characteristics

To obtain maximum battery life and performance, batteries should be:

- recharged as soon as possible after each use and not stored in a discharged state;
- stored at 68°F (20°C) or lower, if possible, and
- recharged annually when not used.

Battery Life

Cyclic Use: The number of charge/discharge cycles depends on the capacity taken from the battery (a function of discharge rate and depth of discharge), operating temperature and the charging method.

Figure 9 shows the relationship between depth of discharge and number of cycles as well as increases of capacity during the early cycles.

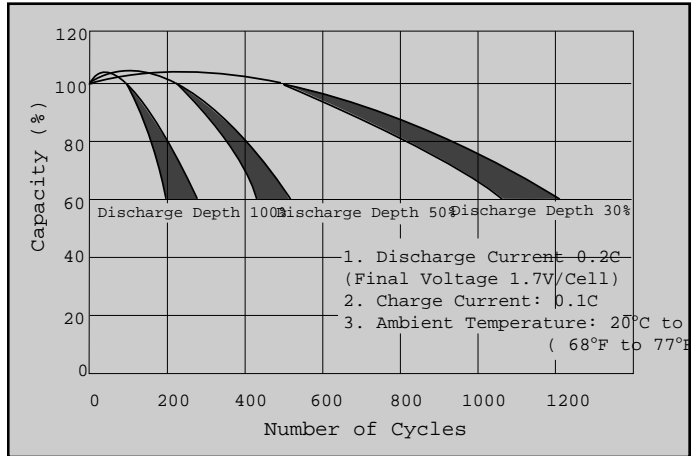

Figure 9: Depth of Discharge vs. Number of Cycles

Standby Use: The float service life, or life expectancy under continuous charge, depends on the frequency and depth of discharge, the charge voltage, and the ambient temperature. At a float voltage of 2.25V to 2.30V/cell and an ambient temperature of 60°F to 77°F (20°C to 25°C) Power-Sonic batteries should last four to five years before the capacity drops to 60% of its original rating.

Figure 10 indicates how capacity changes over time.

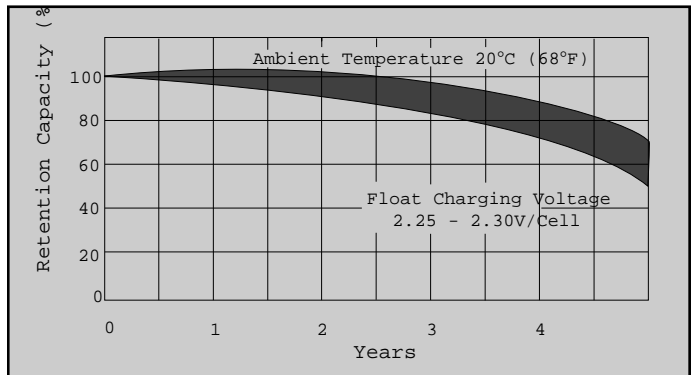

Figure 10: Life Characteristics in Standby Use

PERFORMANCE DATA

The graph in *Figure 11* shows life characteristics in float (standby) service for ambient temperatures ranging from 15°C to 55°C

If prevailing ambient temperatures are well above 20-25°C the life expectancy of this type of battery in float service depends greatly on temperature compensated charging. The typical temperature coefficient is -2mV/cell/°C. The graph shown along side is based on temperature compensated charging.

Figure 11: Service Life at Various Ambient Temperatures

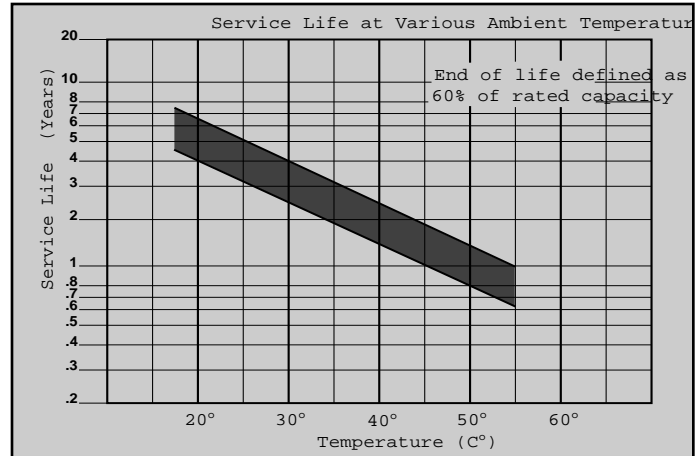

OVER-DISCHARGE PROTEC-

To optimize battery life, it is recommended that the battery be disconnected from the load when the end voltage – a function of the discharge rate – is reached. It is the voltage point at which 100% of the usable capacity of the battery has been consumed or continuation of the discharge is useless because of the voltage dropping below useful levels. (see section on Deep Discharge on page 3)

Discharging a sealed lead-acid battery below this voltage or leaving a battery connected to a load will impair the battery's ability to accept a charge. To prevent potential over-discharge problems, voltage cut-off circuits as shown in *Figure 12* may be used.

Figure 12: Circuits of Over-Discharge Preventive Device

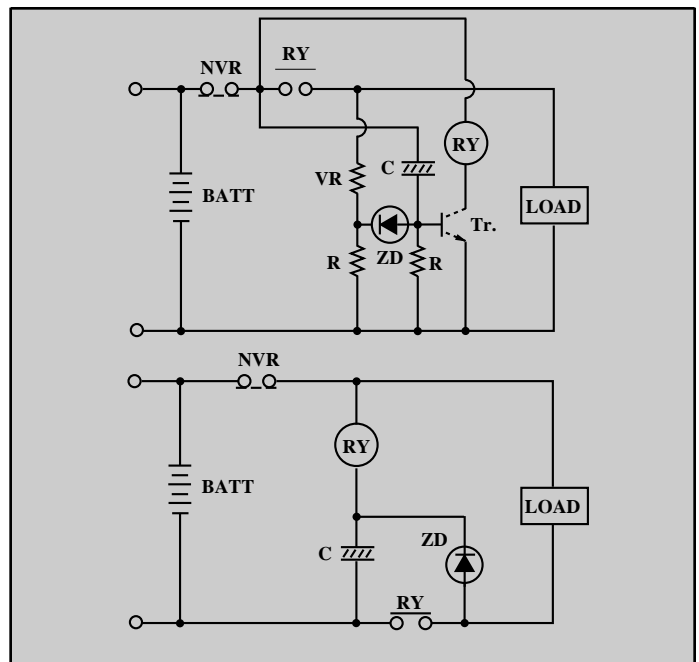

CHARGING

Dependable performance and long service life depend upon correct charging. Faulty procedures or inadequate charging equipment result in decreased battery life and/or unsatisfactory performance. The selection of suitable charging circuits and methods is as important as choosing the right battery for the application.

General

To charge a Power-Sonic battery, a DC voltage higher than the open-circuit voltage of 2.15 is applied to the terminals of the battery. Depending on the state of charge, the cell may temporarily be lower (after discharge) or higher (right after charging) than 2.15 volts. After some time, however, it should level off at about 2.15 volts per cell.

Power-Sonic batteries may be charged by using any of the conventional charging techniques. To obtain maximum service life and capacity, along with acceptable recharge time and economy, constant voltage-current limited charging is recommended.

During charge, the lead sulfate of the positive plate becomes lead dioxide. As the battery reaches full charge, the positive plate begins generating dioxide causing a sudden rise in voltage. A constant voltage charge, therefore, allows detection of this voltage increase and thus control of the charge amount.

CHARGING

Overcharging: As a result of too high a charge voltage excessive current will flow into the battery after reaching full charge causing decomposition of water in the electrolyte and, hence, premature aging.

At high rates of overcharge a battery will progressively heat up. As it gets hotter, it will accept more current, heating up even further. This is called thermal runaway, and can destroy a battery in as little as a few hours.

Undercharging: If too low a charge voltage is applied, the current flow will essentially stop before the battery is fully charged. This allows some of the lead sulfate to remain on the electrodes which will eventually reduce capacity.

Batteries which are stored in a discharged state, or left on the shelf for too long, may initially appear to be “open circuited” or will accept far less current than normal. This is caused by a phenomenon called “sulfation”. When this occurs, leave the charger connected to the battery. Usually, the battery will start to accept increasing amounts of current until a normal current level is reached. If there is no response, even to charge voltages above recommended levels, the battery may have been in a discharged state for too long to recover.

Charging Characteristics

During constant voltage or taper charging, the battery’s current acceptance decreases as voltage and state of charge increase. The battery is fully charged once the current stabilizes at a low level for a few hours.

Caution: Never charge or discharge a battery in a hermetically sealed enclosure. Batteries generate a mixture of gases internally. Given the right set of circumstances, such as extreme overcharging or shorting of the battery, these gases might vent into the enclosure and create the potential for an explosion when ignited by a spark.

If in doubt, or concepts of proper use and care are unclear, contact Power-Sonic’s department for application engineering at 619-661-2020.

Please note that there are two criteria for determining when a battery is fully charged: (1) the final current level and (2) the peak charging voltage while this current flows.

Figure 13 depicts an example of typical charge characteristics for cycle service where charging is non-continuous and peak voltage can, therefore, be higher.

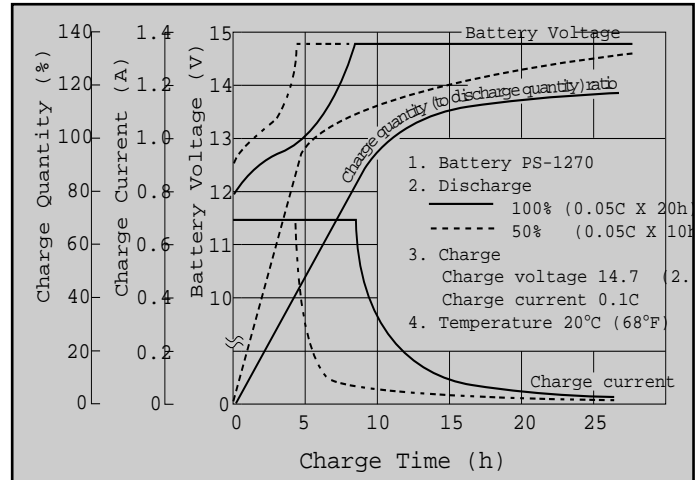

Figure 13: Charge characteristics for 14.7V Constant Voltage

Figure 14 illustrates typical characteristics for standby service type charge. Here, charging is continuous and the peak charge voltage must, therefore, be lower.

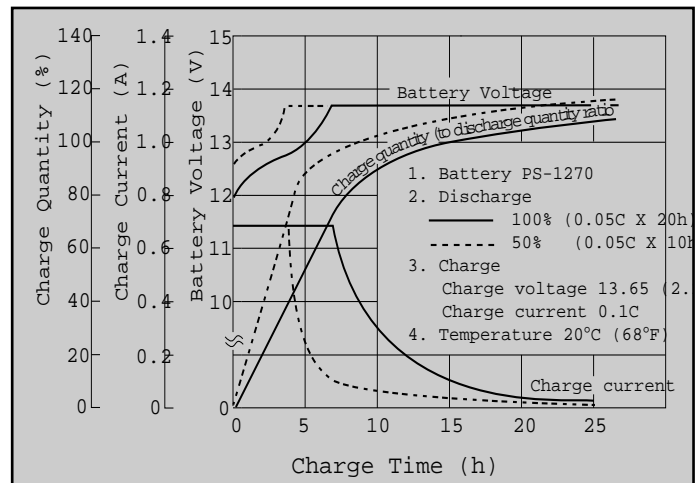

Figure 14: Charge Characteristics for 13.65V Constant Voltage

Charging Methods

Selecting the appropriate charging method depends on the intended use (cyclic or float service), economic considerations, recharge time, anticipated frequency and depth of discharge, and expected service life. The key goal of any charging method is to control the charge current at the end of the charge.

Taper Charging: This is the simplest, least expensive charging method. Either quasi-constant voltage or quasi-constant current characteristics can be built into the charger through combination of transformer, diode and resistance. Of the two, constant potential charging is preferable.

CHARGING

Typical taper chargers are comprised of small transformer-rectifier circuits wherein the transformer is so designed that the current is limited to the maximum initial charge current for the battery. This current is held constant until the terminal voltage and resultant current demand reach a point at which the charge current begins to fall. Although this type of charger can provide a relatively fast recharge, it is basically a constant current device and the charge voltage may be driven too high. Therefore, it must be disconnected, usually within 12-24 hours, or after 100-120% of the preceding discharge has been returned. It is also sensitive to line voltage variations which can cause over- or under-charging. Consequently, this charging method can only be used in cyclic applications

Figure 15 shows an example of a typical diagram and Figure 16 the resultant charge characteristics for this type of basically unregulated charger.

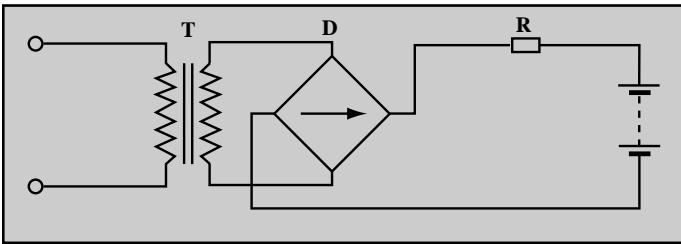

Figure 15: Semi-Constant Current Charging Circuit

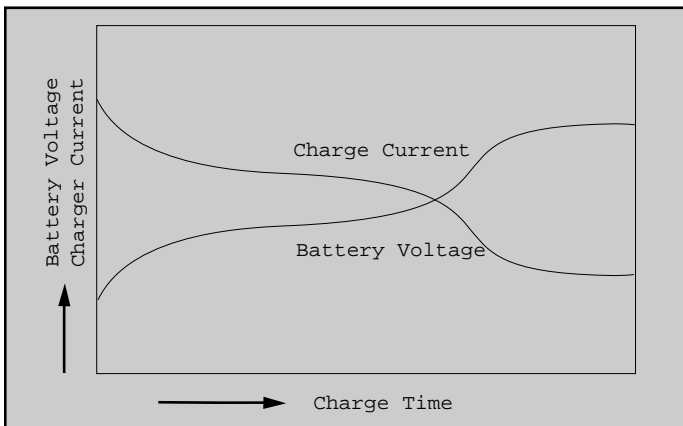

Figure 16: Semi-Constant Current Charge Characteristics

Constant Current Charging: Constant current charging is suited for applications where discharged ampere-hours of the preceding discharge cycle are known. Charge time and charge quantity can easily be calculated,

however an expensive circuit is necessary to obtain a highly accurate constant current. Monitoring of charge voltage or limiting of charge time is necessary to avoid excessive overcharge.

While this charging method is very effective for recovering the capacity of a battery that has been stored for an extended period of time, or for occasional overcharging to equalize cell capacities, it lacks specific properties required in today's electronic environment.

An example of a constant current charge circuit is shown in Figure 17 and the charge characteristics for this type of charger in Figure 18.

Figure 17: Constant Current Charging Circuit

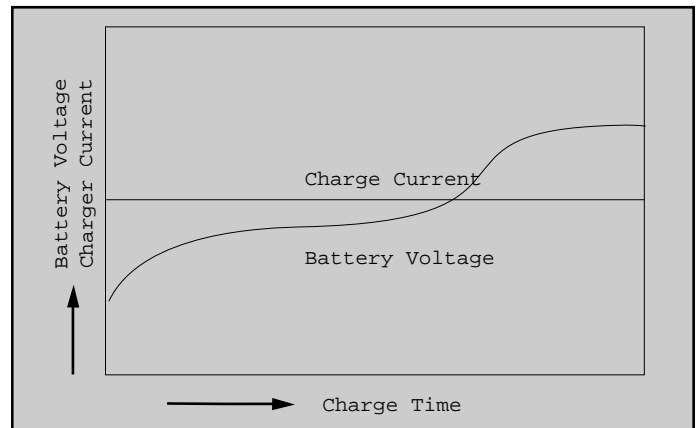
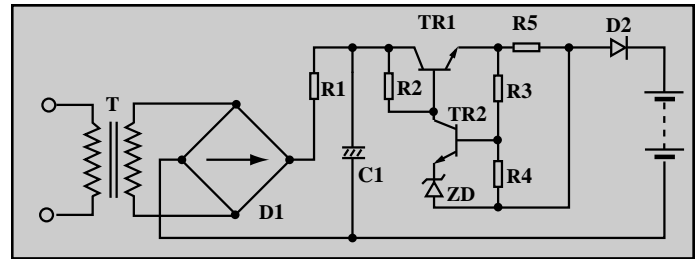

Figure 18: Constant Current Charge Characteristics

Constant Voltage Charging: Constant current/constant voltage charging is the best method to charge Power-Sonic batteries. Depending on the application, batteries may be charged either on a continuous or non-continuous basis. In applications where standby power is required to operate when the AC power has been interrupted, continuous float charging is recommended. Non-continuous cyclic charging is used primarily with portable equipment where charging on an intermittent basis is appropriate.

CHARGING

The constant current/constant voltage charge method applies a constant voltage to the battery and limits the initial charge current. It is necessary to set the charge voltage according to specified charge and temperature characteristics. Inaccurate voltage settings cause over- or under-charge. This charging method can be used for both cyclic and standby applications.

Figures 19 and 20 illustrate examples of a constant current/constant voltage charging circuit and charging characteristics, respectively. The circuit diagram includes a temperature compensation feature for charge voltage to ensure optimum charging conditions regardless of changes in ambient temperature.

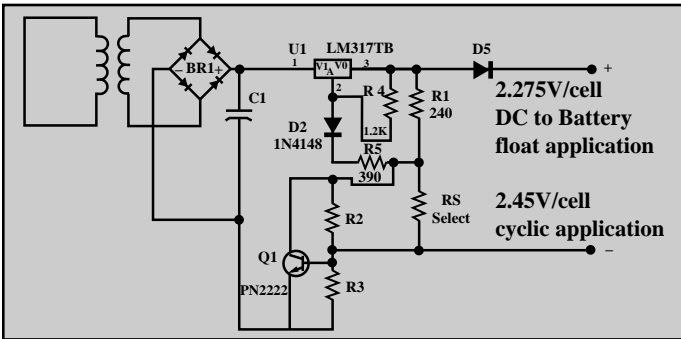

Figure 19: Constant Current/Constant Voltage Charge Circuit

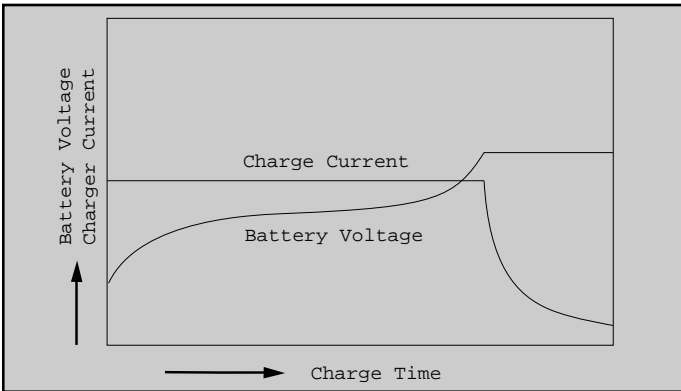

Figure 20: Constant Current/Constant Voltage Charge Characteristics

Charging for Cycle Operation

Cyclic applications generally require that recharging be done in a relatively short time. The initial charge current, however, must not exceed $0.20 \times C$ amps. Just as battery voltage drops during discharge, it slowly rises during charge. Full charge is determined by voltage and inflowing current. When, at a charge voltage of 2.45 ± 0.05 volts/cell, the current accepted by the battery drops to less than $0.01 \times C$ amps (1% of rated capacity), the battery is fully charged and the charger should be disconnected or switched to a float voltage of 2.25 to 2.30 volts/cell. The voltage should not be allowed to rise above 2.45 ± 0.05 volts/cell.

Charging for Standby Operation

Standby applications generally do not require that the battery be charged as fast or as frequently as in cycle operation. However, the battery must be kept constantly charged to replace the energy that is expended due to internal loss and deterioration of the battery itself. Although these losses are very low in Power-Sonic batteries, they must be replaced at the rate the battery self-discharges; at the same time the battery must not be given more than these losses or it will be overcharged. To accomplish this, a constant voltage method of charging called “float charging” is used.

The recommended constant float voltage is 2.25-2.30 volts per cell. Maintaining this float voltage will allow the battery to define its own current level and remain fully charged without having to disconnect the charger from the battery. The trickle current for a fully charged battery floating at the recommended charge voltage will typically hover around the $0.001C$ rate (10mA for a 10AH battery, for example.)

The float charger is basically a constant voltage power supply. As in cycle chargers, however, care must be exercised not to exceed the initial charge current of $0.20 \times C$ amperes.

Two-Step Constant Voltage Charging

This method uses two constant voltage devices. In the initial charge phase the high voltage setting is used. When charging is nearly complete and the charge voltage has risen to a specified value (with the charge current decreased), the charger switches the voltage to the lower setting. This method allows rapid charging in cycle or float service without the possibility of overcharging even after extended charging periods.

The graph in Figure 21 shows charging characteristics, and the diagram in Figure 22 an example of a charging circuit for this type of charger.

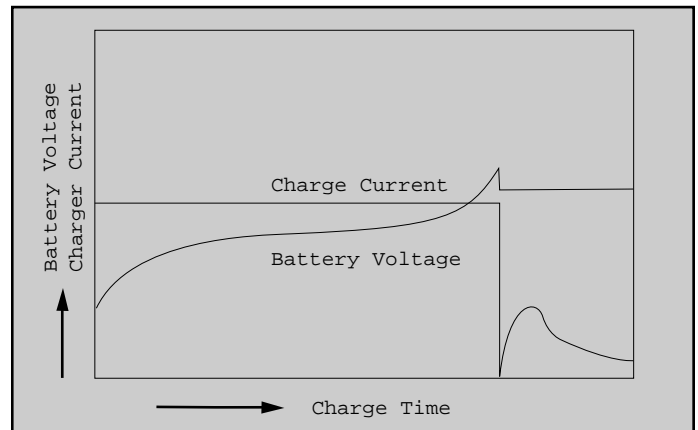

Figure 21: Two-Step Constant Voltage Charge Characteristics

CHARGING

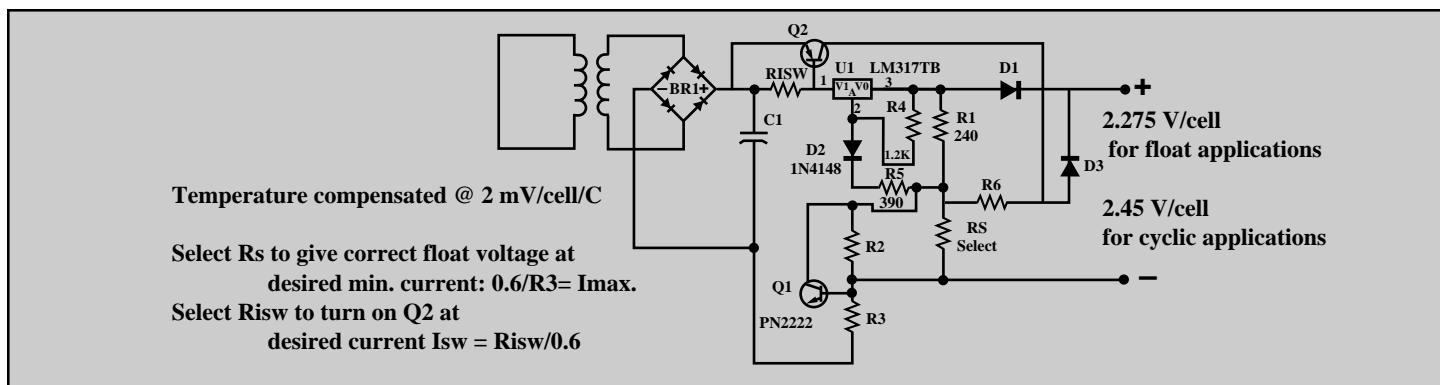

Figure 22: Dual Stage Current Limited Battery Charger

Charging in Series: Lead-acid batteries are strings of 2 volt cells connected in series, commonly 2, 3, 4 or 6 cells per battery. Strings of Power-Sonic batteries up to 48 volts and higher may be charged in series safely and efficiently. However, as the number of batteries in series increases, so does the possibility of slight differences in capacity. These differences can result from age, storage history, temperature variations or abuse.

When a single constant voltage charger is connected across an entire high voltage string, the same current flows through all cells in the string. Depending on the characteristics of the individual batteries, some may overcharge while others remain in a slightly undercharged condition. When charging high voltage strings this way for extended periods it is generally recommended to use a low input voltage inverter to enhance service life and simplify charging requirements.

If one cell is lower in capacity than the others when discharging a long string in series, it may actually reverse polarity even though the total voltage of the string is at or above the cut-off voltage.

To minimize the effects of individual battery differences, use batteries of the same age and history and, if possible, charge in strings of no greater than 24 or 48 volts.

Charging in Parallel: Power-Sonic batteries may be used in parallel with one or more batteries of equal voltage.

When connected in parallel, the current from a charger will tend to divide almost equally between the batteries. No special matching of batteries is required. If the batteries of unequal capacity are connected in parallel, the current will tend to divide between the batteries in the ratio of capacities (actually, internal resistances).

When charging batteries in parallel, where different ratios of charge are to be expected, it is best to make provisions to assure that the currents will not vary too much between batteries. Holding a small resistance in series with each battery is all that is needed

Temperature Compensation

Power-Sonic batteries perform well both at low and high temperatures. At low temperatures, however, charge efficiency is reduced; at temperatures above 45°C, charge efficiency increases so rapidly that there is a danger of thermal runaway if temperature compensation is not precise.

The effect of temperature on charge voltage is less critical in float applications, than in cyclic use where relatively high charge currents are applied for the purpose of short recharge times.

Temperature effects should definitely be considered when designing or selecting a charging system. As a rule of thumb, temperature compensation is desirable in the charging circuit when operating outside the range of 41°F to 95°F (5°C to 35°C) prevailing ambient. The temperature coefficient is -2mV/cell/°C below 20°C in standby service and -6mV/cell/°C below 20°C in cyclic use. For higher temperatures the charge voltage should be correspondingly decreased.

The table in Figure 23 lists recommended charge voltages for different temperatures.

AMBIENT TEMPERATURE	CHARGE VOLTAGE PER CELL	
	Cyclic use	Float Use
4 °F(-20 °C)	2.67-2.7V	2.34-2.39V
14 °F(-10 °C)	2.61-2.71V	2.32-2.37V
32 °F(0 °C)	2.55-2.65V	2.30-2.35V
50 °F(+10 °C)	2.49-2.59V	2.28-2.33V
68 °F(+20 °C)	2.43-2.53V	2.26-2.31V
77 °F(+25 °C)	2.40-2.50V	2.25-2.30V
86 °F(+30 °C)	2.37-2.47V	2.24-2.29V
104 °F(+40 °C)	2.31-2.41V	2.22-2.27V
122 °F(+50 °C)	2.25-2.35V	2.20-2.25V

Figure 23: Temperature Compensated Charge Voltage

APPLICATION NOTES

Power-Sonic rechargeable sealed lead-acid batteries are designed to provide years of dependable service. Adherence to the following guidelines in system design will ensure that battery life is maximized and operation is trouble-free.

- Continuous over- or undercharging is the single worst enemy of a lead-acid battery. Caution should be exercised to ensure that the charger is disconnected after cycle charging, or that the float voltage is set correctly.
- Batteries should not be stored in a discharged state or at elevated temperatures. If a battery has been discharged for some time or the load was left on indefinitely, it may not readily take a charge. To overcome this, leave the charger connected and the battery should eventually begin to accept charge.
- Avoid exposing batteries to heat! Care should be taken to place batteries away from heat-emitting components. If close proximity is unavoidable, provide ventilation. Service life is shortened considerably at ambients above 30°C.
- Although Power-Sonic batteries have a low self-discharge rate which permits storage of a fully charged battery for up to a year, it is recommended that a battery be charged 6-9 months after receipt to account for storage from the date of manufacture to the date of purchase. Otherwise, permanent loss of capacity might occur as a result of sulfation. To prolong shelf life without charging, store batteries at 50°F (10°C) or less.
- Fasten batteries tightly and make provisions for shock absorption if exposure to shock or vibration is likely.
- Although it is possible to charge Power-Sonic batteries rapidly, i.e. in 6-7 hrs., it is not normally recommended. Unlimited current charging can cause increased off-gassing and premature drying. It can also produce internal heating and hot spots resulting in shortened service life. Too high a charge current will cause a battery to get progressively hotter. This can lead to “thermal runaway” and can destroy a battery in as little as a few hours.
- Caution: Never charge or discharge a battery in an airtight enclosure. Batteries generate a mixture of gases internally. Given the right set of circumstances such as extreme overcharging or shorting of the battery, these gases might vent into the enclosure and create the potential for an explosion when ignited by a spark. Generally, ventilation inherent in most enclosures is sufficient to avoid problems.
- Do not place batteries in close proximity to objects which can produce sparks or flames, and do not charge batteries in an inverted position.

- When charging batteries in series (positive terminal of one battery is connected to the negative terminal of another), all batteries in the string will receive the same amount of charge current, though individual battery voltages may vary.

- When charging batteries in parallel (positive terminals are connected to the positive terminal and negative terminals to the negative), all batteries in the string will receive the same charge voltage but the charge current each battery receives will vary until equalization is reached.

- High voltage strings of batteries in series should be limited to twenty 6 volt or ten 12 volt batteries when a single constant voltage charger is connected across the entire string. Differences in capacity can cause some batteries to overcharge while others remain undercharged thus causing premature aging of batteries. It is, therefore, not advisable to mix batteries of different capacities, make, or age in a series string.

To minimize the effects of cell or battery differences, charge the string in 24 volt battery groups through a constant current source with zener diode regulation across individual batteries or battery groups.

- To prevent problems arising from heat exchange between batteries connected in series or parallel, it is advisable to provide air space of at least 0.4” (10mm) between batteries.

- Battery containers, made of ABS plastic or styrene, can sustain damage if exposed to organic solvents or adhesives.

- Recharge time depends on the depth of the preceding discharge and the output current of the charger. To determine the approximate recharge time of a fully discharged battery, divide the battery’s capacity (amp. hrs.) by the rated output of the charger (amps.) and multiply the resulting number of hours by a factor of 1.75 to compensate for the declining output current during charge. If the amount of amp. hrs. discharged from the battery is known, use it instead of the battery’s capacity to make the calculation.

- For best results and generally acceptable performance and longevity, keep operating temperature range between -20°C and +40°C.

- Do not attempt to disassemble batteries. Contact with sulfuric acid may cause harm. Should it occur, wash skin or clothes with liberal amounts of water. Do not throw batteries into fire; batteries so disposed may rupture or explode. Disassembled batteries are hazardous waste and must be treated accordingly. It is unlawful to dispose of batteries except through a recycling center.

GLOSSARY

Ambient Temperature

The prevailing surface temperature to which a battery is exposed.

Ampere

Unit of measurement for electric current.

Ampere-Hour

The product of current (amperes) multiplied by time (hours). Used to indicate the capacity of a battery. Also Amp.Hr. or A.H.

Battery

Two or more cells connected together, most typically in series.

Capacity

The electrical energy available from a cell or battery expressed in ampere-hours.

Available capacity refers to ampere-hours that can be discharged from a battery based on its state of charge, rate of discharge, ambient temperature, and specified cut-off voltage.

Rated capacity ("C") is the discharge capacity the manufacturer says may be obtained at a given discharge rate and temperature.

Cell

The basic building block of a battery. The nominal voltage of a lead-acid battery is 2 volts.

Cell reversal – the act of driving a cell into reverse polarity by excessive discharge.

Primary cell – cell or battery that can be discharged only once.

Secondary cell – the process is reversible so that charging and discharging may be repeated over and over.

Charge

The conversion of electrical energy to chemical energy; the process which restores electrical energy to a cell or battery.

Charge retention refers to a battery's ability to hold a charge. It diminishes during storage.

Charge acceptance quantifies the amount of electric charge which accumulates in a battery.

Float charge maintains the capacity of a cell or battery by applying a constant voltage.

Trickle charge maintains the capacity of a cell or battery by applying a small constant current.

Charge equalization brings all of the cells in a battery or string to the same state of charge.

Discharge

The process of drawing current from a battery.

Deep Discharge – the discharge of a cell or battery to between 80% and 100% of rated capacity.

Depth of Discharge – the amount of capacity – typically expressed as a percentage – removed during discharge.

Self Discharge – the loss of capacity while stored or not in use.

Self Discharge Rate – the percent of capacity lost on open circuit over a specified period of time.

Electrode

Positive or negative plate containing materials capable of reacting with electrolyte to produce or accept current.

Energy Density

Ratio of battery energy to volume or weight expressed in watt-hours per cubic inch or pound.

Gas Recombination

The process by which oxygen gas generated from the positive plate during the final stage of charge is absorbed into the negative plate, preventing loss of water.

Impedance

The resistive value of a battery to an AC current expressed in ohms (Ω). Generally measured at 1000 Hz at full charge.

Internal Resistance

The resistance inside a battery which creates a voltage drop in proportion to the current draw.

Nominal Voltage / Nominal Capacity

The nominal value of rated voltage / the nominal value of rated capacity. The nominal voltage of a lead-acid battery is 2 volts per cell.

Open Circuit Voltage

The voltage of a battery or cell when measured in a no load condition.

Parallel Connection

Connecting a group of batteries or cells by linking all terminals of the same polarity. This increases the capacity of the battery group.

Series Connection

The connection of a group of cells or batteries by linking terminals of opposite polarity. This increases the voltage of the battery group.

Separator

Material isolating positive from negative plates. In sealed lead-acid batteries it normally is absorbent glass fiber to hold the electrolyte in suspension.

SLA Battery

Sealed lead-acid battery, generally having the following characteristics: Maintenance-free, leak-proof, position-insensitive. Batteries of this type have a safety vent to release gas in case of excessive internal pressure build-up. Hence also the term: Valve regulated battery.

"*Gel Cells*" are SLA batteries whose dilute sulfuric acid electrolyte is immobilized by way of additives which turn the electrolyte into a gel.

Standby Service

An application in which the battery is maintained in a fully charged condition by trickle or float charging.

State of Charge

The available capacity of a battery at a given time expressed as a percentage of rated capacity.

Thermal Runaway

A condition in which a cell or battery on constant potential charge can destroy itself through internal heat generation.



Primary Power

- Portable Tools & Instruments
- Hand-held Lights
- Cordless & Portable Cellular Phones
- Power Packs
- Remote or Portable Data Gathering Devices
- Medical Apparatus
- Battery Powered Wheelchairs, Ride-on Toys
- Engine Starting Devices
- Robotics
- Consumer Electronics
- Hobby Craft

Standby Power

- UPS Systems
- Emergency Lighting
- Fire & Burglar Alarm Systems
- Access Control Devices
- Telecommunications Equipment
- Electronic Equipment Requiring Memory Protection
- Solar Powered Systems
- Automotive Electronics

OPERATIONS & WAREHOUSE
POWER-SONIC CORPORATION

9163 Siempre Viva Road
San Diego, CA 92173
Telephone: (619) 661-2020
Fax: (619) 661-3650

SALES & MARKETING
POWER-SONIC CORPORATION

P.O. Box 5242
Redwood City, CA 94063 USA
Telephone: (650) 364-5001
Fax: (650) 366-3662

EUROPE
POWER-SONIC EUROPE LTD.

3 Buckingham Square, Hurricane way
Wickford, Essex SS11 8YQ, England
Telephone: (1268) 560686
Fax: (1268) 560902